

## The Rauland Twenty-Two

... mentioned whenever high quality CRT displays are discussed. Not just a tube, but over a dozen distinct tube configurations, all having the same 314 square inch display surface with 165 inch radius of curvature—so close to flat that we and the information display community call it THE FLAT FACE TUBE.

A dozen different tubes? At least! Imagine all the workable combinations of these design features:

- 53 and 70 degree deflection angles
- Electrostatic or magnetic focus
- 1000 to 2000 line resolution
- Electrostatic or magnetic auxiliary deflection for alphanumerics
- Dual neck and rear projection configurations
- Optional laminated implosion protection

The outstanding capabilities of THE RAULAND TWENTY-TWO are duplicated in our family of TWELVE INCH and SIXTEEN INCH FLAT FACE TUBES. Also available is the TWENTY-FOUR INCH FLAT FACE TUBE—the world's largest flat face display tube. Our TWENTY-TWO is the standard of performance and quality in large PPI and scan-converted radar displays. An advancing information display technology is accepting RAULAND FLAT FACE TUBES as the look of quality where looking really counts.

The next time you're talking CRT displays, invite us to join the discussion. We don't compromise on quality—Why should you?

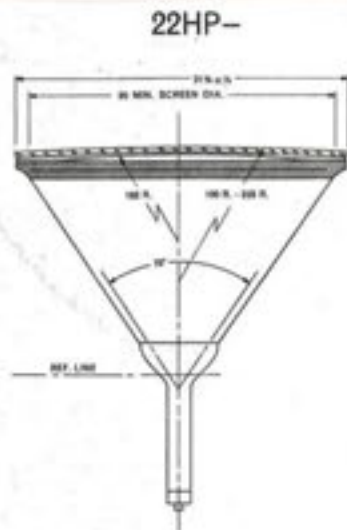

1. 12" Flat Face Tube
2. 16" Flat Face Tube
3. 22" Dual Neck Flat Face Tube
4. 16" Flat Face Tube
5. 22" 53 degree flat face with ES character plates
6. 22" Flat Face Tube
7. 24" Flat Face Tube

Circle Reader Service Card No. 109



THE RAULAND CORPORATION • SPECIAL PRODUCTS DIVISION

5600 W. Jarvis Avenue • Chicago, Ill. 60648 • Telephone (312) 647-8000 A Zenith Subsidiary

Volume 3 Number 5 September/October, 1966

# Information Pienlav

Journal of the Society for Inform

66  
PRINCETON NJ 08540  
RCA LABORATORIES  
BERNARD J LECHNER

# S I D

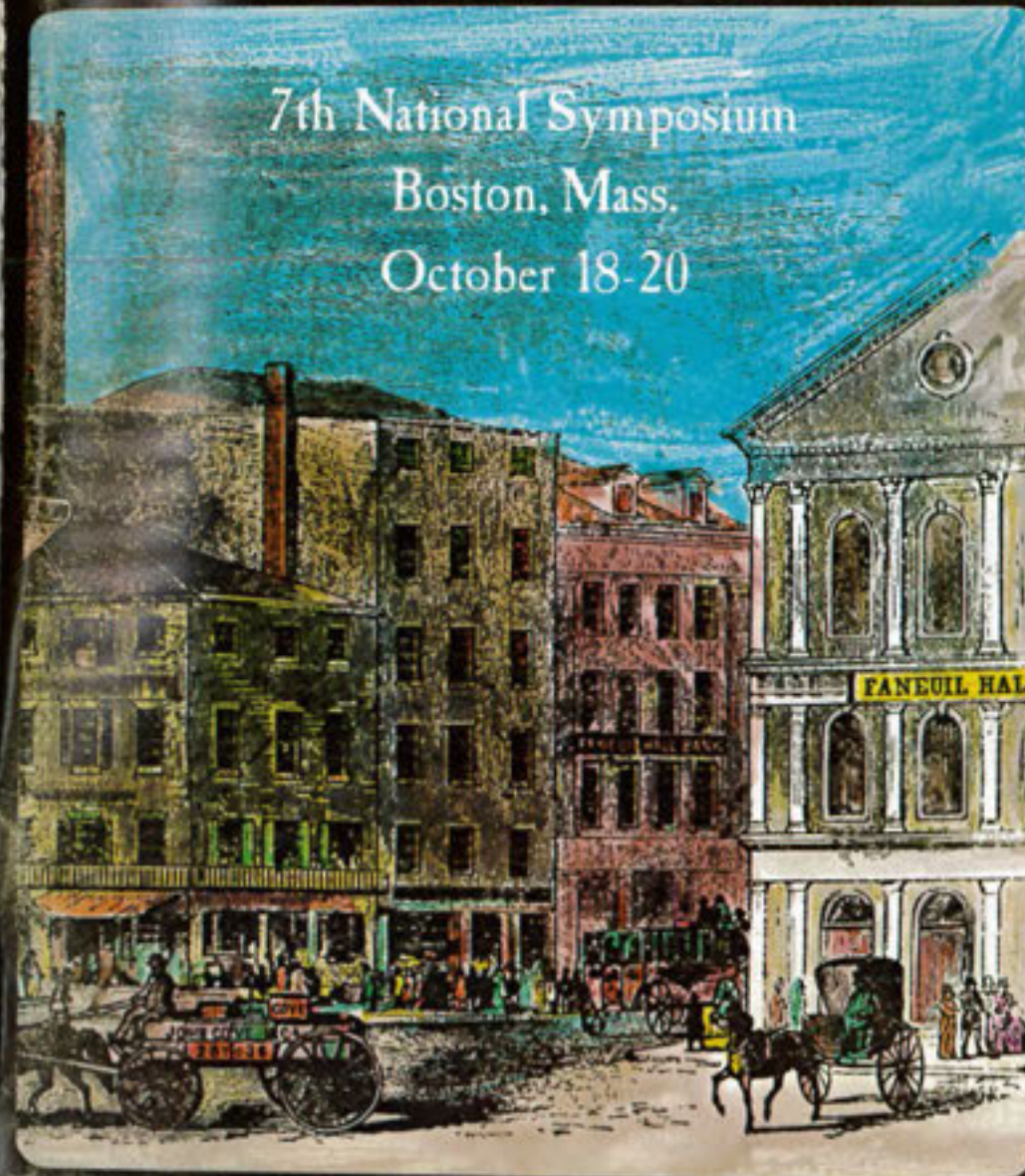

7th National Symposium  
Boston, Mass.  
October 18-20





SEND FOR YOUR FREE COPY



**ALL NEW DIGISWITCH 1967 CATALOG**

including new, reduced price list

Now the most complete catalog on thumbwheel switches ever published, is yours for the asking. It includes descriptions of all DIGISWITCH and MINISWITCH thumbwheel switches, technical data on each, truth tables showing codes and electrical output configurations available, dimensional blue prints of each model, standard performance specifications, new revised prices, order blanks, plus general information such as typical applications and binary reference tables. Copies will be mailed free of charge without obligation. Use the coupon below or call your Digitran representative.

**THE DIGITRAN COMPANY**

A Division of Endevco Corporation  
855 South Arroyo Parkway, Pasadena, California  
Phone: 213/449-3110

MINISWITCH AND DIGISWITCH ARE MANUFACTURED UNDER U.S. PATENTS 3,089,923 AND 3,118,724. OTHER PATENTS PENDING.

Please mail me a copy of Digitran's new catalog

Name \_\_\_\_\_  
Company \_\_\_\_\_  
Street \_\_\_\_\_  
City \_\_\_\_\_ Zip \_\_\_\_\_ State \_\_\_\_\_



11168 Santa Monica Blvd.  
Los Angeles, Calif. 90025  
(213) 892-1087

**OFFICERS**

William P. Bethke ..... President  
Sol Sherr ..... Vice-President  
Carl Machover ..... Secretary  
Edith Bairdain ..... Treasurer

**Executive Secretary**

Dr. H. R. Luxenberg

**REGIONAL DIRECTORS**

**Northeast Region** ..... Fordyce Brown  
Glenn E. Whitham  
George J. Chafaris  
**Southeast Region** ..... B. J. Lohr  
Raymond Sabeh  
Ernest Storrs  
**Central Region** ..... Richard M. Beindorff  
Victor Bernin  
J. Hoagbin  
**Western Region** ..... Phillip Damon  
David K. Robbins  
R. Aiken

**COMMITTEE CHAIRMEN**

**Publications** ..... L. Seeburger  
**Definitions & Standards** ..... Dr. Carlo P. Crocetti  
**Honors & Awards** ..... Rudolph Kuehn  
**Membership** ..... Phillip Damon  
**Nominating** ..... J. Redman  
**Convention** ..... Fordyce Brown  
**Planning** ..... G. Whitham & R. Bernberg

**EDITORIAL ADVISORY BOARD**

Mr. William Ross Aiken  
Dr. Edith M. Bairdain  
Mr. William P. Bethke  
Dr. Carlo P. Crocetti  
Dr. Ruth M. Davis  
Mr. Theodore Hamburger  
Dr. H. R. Luxenberg  
Mr. Petro Vlahos  
Dr. A. M. Zarem

**Information Display**

Published bi-monthly by  
Information Display Publications, Inc.  
647 North Sepulveda Boulevard  
Bel Air, Los Angeles, Calif. 90049  
(213) GR 6-4711

[Correspondence regarding advertising, reprints and non-membership subscriptions should be directed to the above address.]

**EDITORS & PUBLISHERS** ..... Hal Spector  
Martin H. Waldman  
**FEATURE EDITOR** ..... Robert Mount  
**NEWS EDITOR** ..... Lew Darling  
**RESEARCH DIRECTOR** ..... Robert Garrett  
**ART DIRECTOR** ..... M. K. Myers  
**EDITORIAL ASSISTANT** ..... P. Cowan  
**BUSINESS MANAGER** ..... A. Yeadon  
**PRODUCTION MANAGER** ..... D. Carver  
**CIRCULATION MANAGER** ..... G. Bacom  
**ADVERTISING** ..... Donald Meeker  
Ivan Berkoff  
Mark Lazarus  
Bud Kader

**CLOSING DATES**  
Editorial closing date is fifteenth day of the month preceding month of issue. Advertising closing is first day of the month of issue.  
**CHANGE OF ADDRESS**  
To change address, send old mailing label imprint as well as new address. Allow 30 days for change.

**SUBSCRIPTIONS**  
No charge to members of the Society for Information Display. All others \$12 per year. \$20 for two years. Payable in advance.  
©1966 BY INFORMATION DISPLAY PUBLICATIONS, INC. ALL RIGHTS RESERVED. REPRODUCTION IN WHOLE OR PART WITHOUT WRITTEN PERMISSION IS PROHIBITED.

CONTROLLED CIRCULATION POSTAGE PAID AT LOS ANGELES, CALIFORNIA  
INFORMATION DISPLAY, SEPTEMBER/OCTOBER, 1966

青年跳金門橋  
金門橋前日晨。發生壹  
橋自殺案。相信已跳橋自殺  
年式十式歲。據報于晨十  
越橋欄而跳下海。惟其父親  
救起。  
機師則仍設法留  
機螺旋槳。又生  
機師則仍設法留  
下海。式人隨由壹  
救起。  
於拯救  
度頓軍營  
高中。機  
落於。飛機於火起後  
魯空軍其  
降。機員八人均為預備軍官  
南五里之海面  
艇逃出獲  
醫院。  
進行  
人

$$2\pi - (\omega/2)$$

$$\int_{-\pi/2}^{\pi/2} \cos^2 \eta d\eta$$

$$\int_{(\nu/2) - (\omega/4)}^{(\nu/2) + (\omega/4)} \sin^2 \nu d\nu$$

$$\frac{\nu \sin 2\mu}{2} - \frac{\cos}{2}$$

6.9200	-3.9900	4.0867	4.0775	4.0699	4.0543	10.66110
6.9200	-3.9900	4.3916	4.3900	4.3896	4.3932	11.24929
6.9200	-3.9900	4.7433	4.7515	4.7604	4.7894	11.93143
6.9200	-3.9900	5.1533	5.1745	5.1958	5.2588	12.73209
6.9200	-3.9900	5.6376	5.6762	5.7142	5.8239	13.68523
6.9200	-3.9900	6.2183	6.2808	6.3421	6.5171	14.83924
6.9200	-3.9800	3.0047	2.9754	2.9491	2.8839	8.60752
6.9200	-3.9800	3.1729	3.1460	3.1219	3.0623	8.92681
6.9200	-3.9800	3.3598	3.3358	3.3144	3.2619	9.28244

IF RESOLUTION AND RECOGNIZABILITY ARE IMPORTANT TO YOU,  
WE WOULD SUGGEST THAT YOU USE THE NEW TD 8484 VIDICON  
IN YOUR TELEVISION CAMERA.

MANUFACTURED BY  
**GENERAL ELECTRODYNAMICS CORPORATION**  
4430 FOREST LANE • GARLAND, TEXAS

## Adams Associates Probes Computer Displays, Publishes New Review

The First Comprehensive  
Source of Information and  
Critical Evaluation on This  
Rapidly Expanding Field



CAMBRIDGE, MASSACHUSETTS — Charles W. Adams, President of Adams Associates, reported today that the response to *The Computer Display Review* published only two months ago has been extraordinary. "We anticipated a strong interest in computer graphics on the part of private industry and government agencies," said Mr. Adams, "but, quite frankly, the response has surprised us. Our subscribers, both here and abroad, include not only military and government agencies, universities, research laboratories, and the leading computer and peripheral equipment manufacturers, but also a wide variety of representatives of the major industries."

In its many years of developing and working with computer-based display equipment and techniques, Adams Associates has long recognized the need for a single source of information and critical evaluation of this entire field. *THE COMPUTER DISPLAY REVIEW* answers this need. Divided into seven sections containing more than 500 pages of text, tabular and illustrative material the information in it results from an intensive effort by Adams Associates during the past year and a half to gather, analyze and evaluate data on all display equipment now available or under development in the free world.

"As computer consultants rather than publishers," Mr. Adams said, "we are offering not a book but a service. To keep our subscribers

abreast of the latest developments in this rapidly expanding field, a full-time staff will continue its research, visiting equipment manufacturers and field installations. New developments in display hardware, software, applications and trends will be thoroughly evaluated and information on them released in the form of supplements every four months. In addition, abstracts of timely articles on applications and techniques as well as papers contributed to or written expressly for the *REVIEW* by well-known specialists will be included."

By making *THE COMPUTER DISPLAY REVIEW* available on a subscription basis to corporate sponsors, the substantial cost of producing it—which would be prohibitive for any one client—will be shared by interested firms and government agencies. The corporate sponsorship fee of \$750 is a one-time charge which includes one annual \$150 subscription to the *REVIEW*. All additional subscriptions and renewals are \$150 a year. Since both the U.S. and Canadian governments are already corporate sponsors, all of their agencies are eligible for the \$150 subscription rate. So too are all accredited universities, colleges and secondary schools for which the corporate sponsorship fee has been waived.

For further information on *THE COMPUTER DISPLAY REVIEW*, please call or write to John T. Gilmore, Jr., Vice President.

charles w.  
**adams associates**  
inc.

575 TECHNOLOGY SQUARE · CAMBRIDGE · MASSACHUSETTS 02139 (617) 491-6555

## Master Specialties Company Series 90E Miniature Tellite Switch....

# Versatility!

1 IN ELECTRICAL FUNCTION AND INSTALLATION EASE

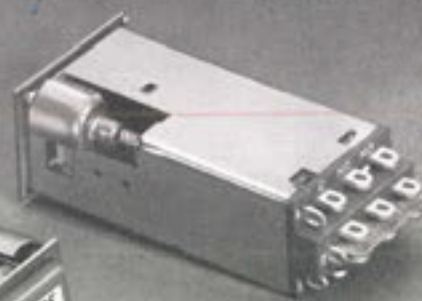

2 IN INFORMATION DISPLAY, PANEL LAYOUT AND STYLE



3 IN OPERATIONAL MAINTENANCE AND QUICK MODIFICATION

GET MAXIMUM CONTROL  
IN MINIMUM SPACE WITH  
THE SERIES 90E  
ILLUMINATED PUSHBUTTON  
SWITCH

1 Wide Choice of Electrical Characteristics—easy to install and wire.

Specify 2PDT or 4PDT snap-action switches in momentary or alternate action, or in momentary action with holding coil. Lamp circuits include 6, 12, or 28 volt, or special neon lamp 115 volt. Mount from the panel front using integrated mounting sleeves. No brackets or hardware to show from the panel front. All terminals at rear for easy wiring, and they are non-corrosive gold plated. Each terminal will accept two #20 wires.



2 Smart, functional styling with maximum information display legend area.

Choose from black or grey, standard lens holders or optional full-view lens, both offering maximum legend area. Legends can be included with your order . . . and they are reverse engraved to withstand long wear without effacing. For design esthetics in panel layout, mount units in rows, stacks or matrices. Smooth, unobstructed sides permit close grouping for maximum control in minimum space. Two lamp illumination provides for horizontal or vertical split display or two color full display. Get extra-margin reliability in one color full display from two-lamp operation.



3 No Tools Required for Relamping, Filter or Legend Change—from the Panel Front!

Replace lamps or change color filters or legends at any time simply by removing the light capsule with your fingers. No tools needed. Removable, colored slab filters permit quick modification of color-coded indication. If needed, legends can be quickly changed at any time.



Complete Design Data is included in  
CATALOG 2008

**MASTER  
SPECIALTIES  
COMPANY**

1640 MONROVIA, COSTA MESA, CALIFORNIA  
TELEPHONE AREA CODE 714: 642-2427

REGIONAL OFFICES AND TELEPHONE  
ALABAMA: Huntsville ..... 205-536-7415  
CALIFORNIA: Costa Mesa ..... 714-642-0114  
CALIFORNIA: Sunnyvale ..... 408-345-9292  
FLORIDA: Winter Park ..... 305-647-0300  
ILLINOIS: Chicago ..... 312-282-7112  
NEW YORK: Syracuse ..... 315-479-9191  
NEW YORK: Valley Stream, L.I. .... 516-561-2334  
TEXAS: Dallas ..... 214-357-9459

Circle Reader Service Card No. 7 9

# Information Display

Journal of the Society for Information Display

## ARTICLES

- Multi-Sensor Displays—Two Approaches  
by M. D. Harsh ..... Page 24  
Reviews results of an RCA survey of signal display in multi-sensor systems, and analyzes these results.
- IBM's Graphic Display System  
by Russell J. Houldin ..... Page 34  
Presents a detailed discussion of IBM's graphic display system, its operation, and its capabilities.
- Recording Media  
by H. R. Luxenberg and R. L. Kuehn ..... Page 41  
Previews chapter on this topic in the book Display Systems Engineering, to be published by McGraw-Hill in 1967.
- Interactive Displays for Document Retrieval  
by H. Borko and H. P. Burnaugh ..... Page 47  
Describes SDC's Bibliographic On-Line Display, an interactive document storage/retrieval system.

## FEATURES

- The Seventh National SID Symposium ..... Page 54  
Presents details of the Seventh SID Symposium, including an abstract of every scheduled and standby paper.
- EDITORIAL ..... Page 13
- FALL JOINT COMPUTER CONFERENCE ..... Page 64
- ID AUTHORS ..... Page 67
- AGARD/NATO MEETING ..... Page 68
- ID READOUT ..... Page 71
- ON THE MOVE ..... Page 78
- NEW PRODUCTS ..... Page 80
- NEW LITERATURE ..... Page 92
- SUSTAINING MEMBERS ..... Page 92
- ID ADVERTISERS ..... Page 94

## THE COVER

The old and the new are combined in this portrayal of colonial display techniques and the emblem of the Society for Information Display. Artist George Guon, of TRW Redondo Beach, California, utilizes as his main illustrations colored reproductions of colonial engravings portraying old Boston, site of the 7th National Symposium of the SID. Highlighting the cover is the official SID symbol, being made available at the Symposium in sterling silver with baked-blue enamel, either as a tie-tack clasp or as a standard pin clasp.

### Unforgettable

rear-projection  
readouts...



shelly

12

binary input  
to visual display  
with memory!

The Shelly MBR-100 Readout accepts four line parallel 8-4-2-1 binary code, decodes it into 10 or 12 messages, displays and holds any message upon receipt of an "enable" pulse. The solid-state memory will hold a message until another "enable" pulse is applied to produce a display of the message decoded at that instant. Each unit consists of 12 parallel, miniature optical systems for message projection, a silicon NPN switch memory system, and a solid-state decoder with drivers, gates and complementary function generators... all in a unit 0.754" wide, 1.115" high and 5.17" long! Completely modular, units can be arrayed vertically or horizontally in housings that permit quick relamping or field change of color filters or film reticles from the panel front... without tools of any kind. If your application requires intermittent display of continuous binary input data... and space is at a premium... don't forget the Shelly MBR-100. Your images will be brighter, sharper and larger... and every message can become a memorable event!

Write for Literature.

shelly

Rear-Projection Readouts  
Pushbutton Switches  
Indicator Lights  
Electronic Interface Devices

SHELLY ASSOCIATES, INC.

111 Eucalyptus Drive, El Segundo,  
California 90245

(213) 322-2374 • TWX (213) 322-1345

Representatives in Major Cities



With the new Milgo Digital Plotting System, you output only the end points on lines up to 42" long — the plotter does the rest... with no deterioration of the plotter's normal dynamic accuracy. There is never a second tier subroutine to compute the length of a line! **Result:** reduced computer programming, reduced computer output time, reduced plotting time.

The Milgo DPS-6 includes a choice of off-line readers, plus either a vertical or horizontal plotter. And the system provides for all standard

digital inputs plus straight analog. It accepts magnetic tapes recorded in either gapped, gapless or long record format. An optional core storage buffer allows up to 10,800 bits between gaps.

Send for a brochure-full of additional features on the Milgo DPS-6. Write or call Milgo Electronic Corporation 7620 N.W. 36th Avenue, Miami, Florida 33147. Phone 305-691-1220. TWX 305-696-4489.

milgo



## Now... save programming steps on every plot

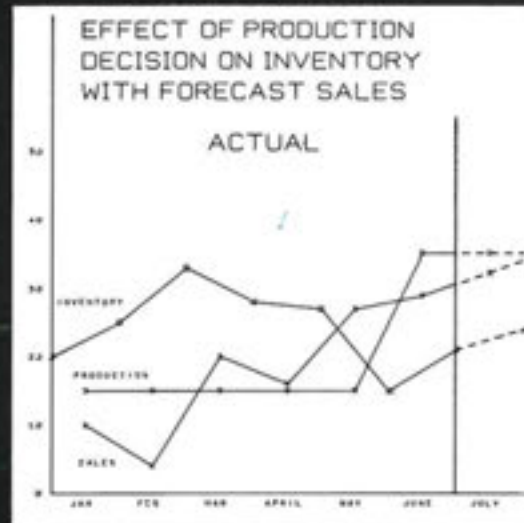

Before: 450 program steps. Now: 300

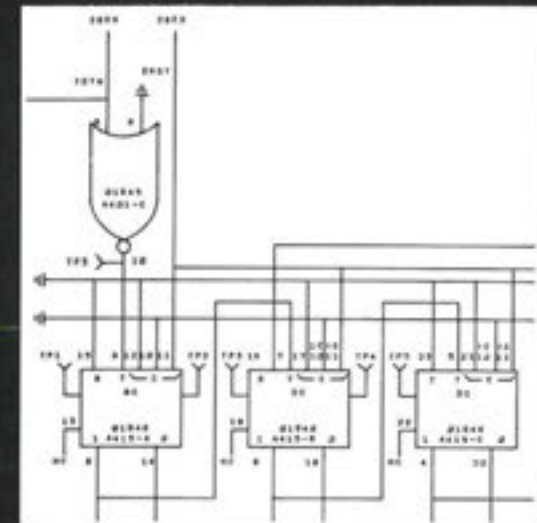

Before: 1000 program steps. Now: 700

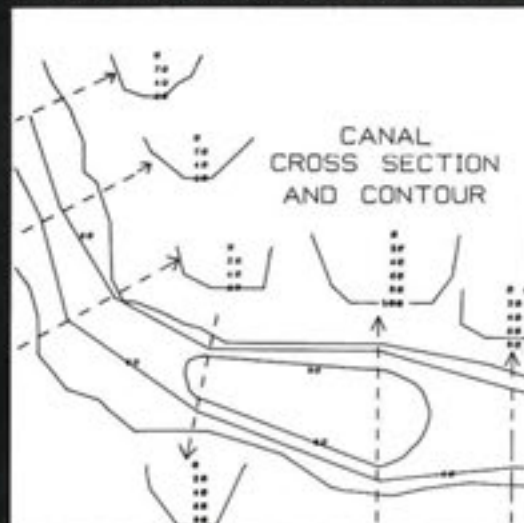

Before: 600 program steps. Now: 500

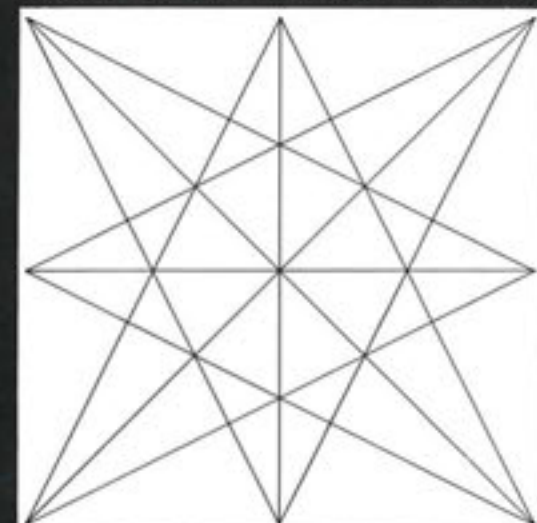

Before: 54 program steps. Now: 14

# Why IEE rear-projection readouts make good reading

Not the kind of good reading you'd curl up with on a rainy night. But a more important kind if you're designing equipment that requires message display. Reason is that IEE readouts are the most readable readouts around. If you've seen them, you know this to be fact. If you haven't as yet, here is why our readouts make such good reading:



## WIDE-ANGLE READABILITY

IEE's unique combination of single-plane projection, flat viewing screen, balanced ratio of brightness/contrast, and big, bold characters makes for wide-angle clarity and long viewing distances.

## OTHER WAYS IEE READOUTS MAKE GOOD SENSE

As if the superior readability of our readouts weren't enough, here are a few reasons why IEE readouts make good sense in other areas:



## SINGLE-PLANE PRESENTATION

No visual hash of tandem-stacked filaments. IEE readouts are miniature rear-projectors that display the required messages, one at a time, on a non-glare viewing screen. Only the message that's "on" is visible.



## INFINITE DISPLAY VERSATILITY

Because our readouts use lamps, lenses, film, and a screen, they can display literally anything that can be put on film. That means you have up to 12 message positions with each readout to display any combination of letters, words, numbers, symbols, and even colors!



## EASY-TO-READ CHARACTERS

Since IEE readouts can display anything that can be put on film, you're not limited to thin wire filament, dotted, or segmented digits. Order your IEE readouts with familiar, highly legible characters that meet human factors and Mil Spec requirements. This section from our sample type sheet gives you an idea of the styles available that offer optimal stroke/width/height ratio for good legibility.



## FIVE SIZES TO PICK FROM

IEE readouts now come in five sizes providing maximum character heights of 1/4", 3/8", 1", 2", and 3 1/2". The smallest is the new Series 340 readout that's only 1/4" H x 1/2" W, yet can be read from 30 feet away. The largest, the Series 80, is clearly legible from 100 feet away.

## BALANCED BRIGHTNESS/CONTRAST RATIO

The chart below is a reasonable facsimile of character brightness and how



it affects readability. The background is constant, but the brightness increases from left to right. You can draw your own conclusions, armed with the fact that IEE readouts give you up to 90 foot lamberts of brightness. Brightness, however, isn't the sole factor in judging readability. Background contrast is equally important—a fact we've simulated below, reading from left to right.



Obviously, brightness without contrast or vice versa, doesn't do much for readability. A balanced ratio of both gives you the crisp legibility of IEE readouts.



7720 Lemona Avenue, Van Nuys, California  
Phone: (213) 787-0311 • TWX (910) 495-1707  
Representatives in Principal Cities

## CALL YOUR NEAREST IEE REPRESENTATIVE FOR A DEMONSTRATION AND APPLICATION INFORMATION:

- ALABAMA**  
Huntsville  
MEDCO ASSOC. INC.  
Suite 90, Holiday Office Center  
205-881-3721
- ARIZONA**  
Phoenix  
GRAMER AND COMPANY  
444 W. Camelback Road  
602-279-1231
- CALIFORNIA**  
Van Nuys  
INDUSTRIAL ELECTRONIC ENGINEERS, INC.  
7720 Lemona Avenue  
213-787-0311
- Palo Alto**  
McGILL AND MCGILL  
809 San Antonio Road  
415-321-0905
- San Diego**  
L. L. STOKES  
4438 Ingraham Street  
714-274-6281
- COLORADO**  
Denver  
HYER ELECTRONICS COMPANY  
E. Bellview & Valley Highway  
P. O. Box 22227  
303-771-5285
- CONNECTICUT**  
Hamden  
ELTRON ENGINEERING SALES, INC.  
2341 Whitton Avenue  
203-288-9276
- FLORIDA**  
Jedialantic  
MEDCO ASSOC. INC.  
24 Wavercrest Drive  
305-723-6924
- ILLINOIS**  
Chicago  
MAGNUSON ASSOCIATES  
5639 W. Fullerton Avenue  
312-622-6322
- KANSAS**  
Leawood  
POLY-ONICS, INC.  
4434 West 90th Terrace  
913-648-4173
- MARYLAND**  
Ashton  
BIECHLER ASSOCIATES, INC.  
17733 New Hampshire Ave.  
301-924-4507
- Baltimore**  
BIECHLER ASSOCIATES, INC.  
7353 Yorktowne Drive  
301-825-8222
- MASSACHUSETTS**  
Newtonville  
ELTRON ENGINEERING SALES, INC.  
246 Walnut Street  
617-332-6975
- MICHIGAN**  
Southfield  
S. STERLING COMPANY  
21250 10 1/2 Mile Road  
313-442-5656
- MINNESOTA**  
St. Paul  
MAGNUSON ASSOCIATES  
1246 West 7th Street  
612-227-8495
- MISSOURI**  
Hazelwood  
POLY-ONICS, INC.  
47 Village Square Shopping Center  
314-837-0597
- NEVADA**  
Las Vegas  
SYSTEMS DESIGN CORPORATION  
900-1 West Bonanza  
702-382-3037
- NEW MEXICO**  
Albuquerque  
HYER ELECTRONICS COMPANY  
1st National Bank Bldg., East  
Suite 1213  
Central & San Mateo N.E.  
505-268-6744
- NEW YORK**  
Baldwin  
B. S. TAYLOR CORPORATION  
2270 Grand Avenue  
516-223-8000
- Rochester**  
OSSMANN COMPONENT SALES CORP.  
830 Linden Avenue  
716-586-4940
- Syracuse**  
OSSMANN COMPONENT SALES CORP.  
5858 Mallory Road East  
315-454-4477
- Vestal**  
OSSMANN COMPONENT SALES CORP.  
1901 Vestal Pkwy.  
607-785-9947
- NORTH CAROLINA**  
Bethania  
THE CANDOR COMPANY  
919-924-1480
- OHIO**  
Cleveland  
S. STERLING COMPANY  
5827 Mayfield Road  
216-442-8080
- Dayton**  
S. STERLING COMPANY  
3300 S. Dixie Drive  
513-298-7573
- OREGON**  
RAY JOHNSTON CO.  
1011 N.E. 69th St.  
Seattle, Washington  
(206) LA 4-5170
- PENNSYLVANIA**  
Millersville  
BIECHLER ASSOCIATES, INC.  
P. O. Box 38  
717-872-2793
- Pittsburgh**  
RUSSELL F. CLARK COMPANY  
10517 Lindberg Avenue  
412-242-9500
- TEXAS**  
Dallas  
NORVELL ASSOCIATES, INC.  
P. O. Box 20279  
214-357-6451
- Houston**  
NORVELL ASSOCIATES, INC.  
6440 Hillcroft  
713-774-2568
- WASHINGTON**  
Seattle  
RAY JOHNSTON CO.  
1011 N.E. 69th St.  
(206) LA 4-5170
- CANADA**  
Ottawa, Ontario  
WHITTAKER ELECTRONICS LTD.  
42 Howden Avenue  
613-722-7658
- Rosbore, Quebec**  
WHITTAKER ELECTRONICS LTD.  
P. O. Box 216  
514-684-3000
- Weston, Ontario**  
WHITTAKER ELECTRONICS LTD.  
1885 Wilson Avenue  
416-247-7454
- New Westminster, British Columbia**  
WHITTAKER ELECTRONICS LTD.  
324 Decarie St.  
604-936-2244



EDITORIAL

## WINDOW ON THE WORLD

Let us journey into the 1970-1980 era and speculate on what types of display devices and systems might exist. Such speculation may disclose a number of exciting technical challenges which would be of value in directing our long-range research and development efforts. In particular, let us consider future applications of display technology to the home, business and government environments.

Imagine sitting in your home in front of a display screen enjoying visual access to major libraries, university classrooms, art centers and museums of the world. Programming would be completely at your command. The display would appear in full color and possess lithographic quality. Imagine taking a visual vacation through our own National Parks, with the camera under your control. Add three dimensional viewing and "you are there". A home display of this type would be truly a "Window on the World". The same system could provide a televised phone service and represent a major convenience in shopping for all forms of household needs.

In the business environment, much has been written regarding the utility of computed displays for real-time management control and rapid retrieval and dissemination of scientific information. An equal, if not greater, impact could be made by applying display technology to routine business functions. For example, imagine an automated purchasing function in which the user could dial directly into any manufacturer's catalog, electronically turn the pages, select, order and bill within a few seconds. Similarly consider the application of display technology to a nationwide or even world-wide letter transmittal service. The ever increasing flow of paper work from personal letters to business and government correspondence will virtually necessitate a mail system wherein no paper is physically transported.

The military command and control centers of the future will feature full-color ultra-high resolution displays of sufficient brightness for viewing under normal ambient lighting. These centers will be interconnected by a world-wide communication satellite system for interchange of both alphanumeric and high definition video. Although computer driven displays will certainly be of continuing value, future command displays will also permit real-time viewing of military engagements. This capability could avoid misinterpretation of events and contribute one more safeguard to World peace. A system permitting rapid overall evaluation of World events would no longer be considered a prerogative of high level military personnel, but an indispensable tool of a modern military organization.

It is apparent that many, if not all, of these "Window on the World" display systems will be implemented since we can already see many of the components and subsystems receiving intensive development effort. Ultra-wideband optical transmission channels, capable of simultaneously transmitting all television broadcasts in New York City, have been

demonstrated. Earth control of a television camera on the moon is a reality and satellite transmission of conventional television is an everyday occurrence. Computers with nano-second computing times are at least in the design stage. High speed facsimile transmission of entire books has been demonstrated. Furthermore, advances in holography point the way to three dimensional displays. There are, however, two critical areas where device development has lagged. A truly high resolution monochrome or color camera is a missing link, due in part to the adoption of the 525 line television standard. The second device development which is even further behind is the all important display device. A major breakthrough is needed to generate ultra-high resolution full color displays. We can no longer settle for minor performance improvements based on existing techniques. What is needed is far greater research efforts to explore both new and old physical phenomena applicable to display generation.

"Window on the World" is a technical challenge. The needs to be met by research are apparent. Its benefits to individual members of our society in terms of leisure time activities, education, defense of our country and improving our economy are of immeasurable value. Let us each contribute what we can according to our talents.

DR. G. J. CHAFARIS  
Northeast Regional Director, SID

*George Chafaris is a member of the Mid-Atlantic Chapter of the Society for Information Display. He is also a Northeast Regional Director of the Society. Dr. Chafaris received his BSEE degree from the University of Wisconsin in 1944. He then joined the Los Alamos Atomic Bomb Laboratory where he was engaged in the design and development of circuitry for nuclear test purposes.*

*In 1946 he began graduate studies at the University of Illinois receiving the MSEE and PhD degrees in 1947 and 1951, respectively. While at the University he was associated with the Betatron program as a research assistant and was also a teaching assistant in the Department of Electrical Engineering.*

*In 1951, Dr. Chafaris joined General Electric's Electronics Laboratory at Syracuse, New York where he engaged in advanced development and application of electronic storage, display and imaging devices to commercial and military systems. In 1959 he established the Laboratory's Data Recording and Display Subsection. As manager of this group, he guides research and development on new recording and display devices and systems based on thermoplastic, oil film and photographic media. He holds three patents in recording and display and is a member of Sigma Xi, Eta Kappa Nu and IEEE.*

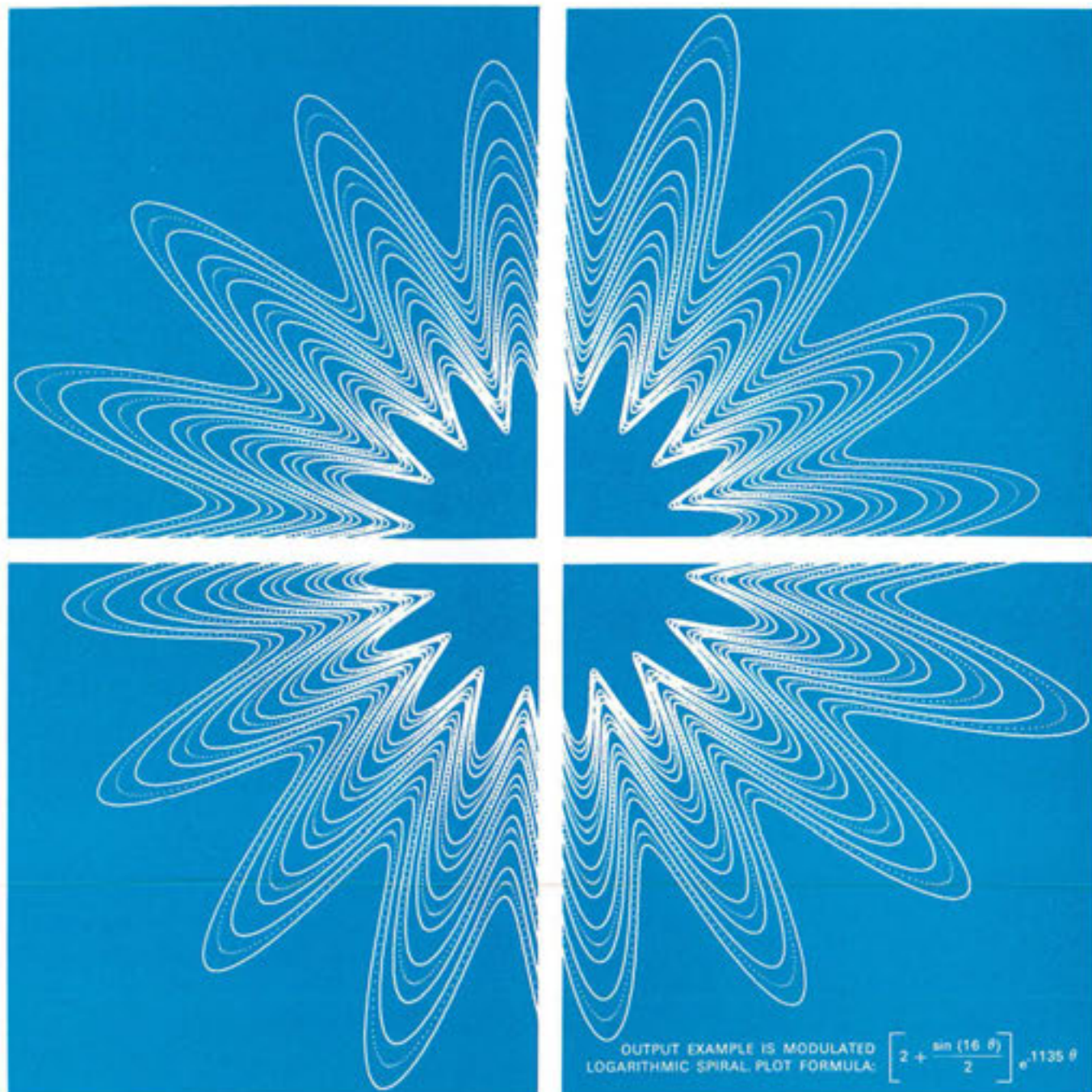

The CONTROL DATA® 280 Recorder and Display Can Deliver This Kind of Data at the Rate of One Hardcopy or Twenty 35 mm. Frames Per Second Using only a Few Seconds of Computer Time.



### NO JOB FOR A NOVICE

**You Need Versatility.** The 280 gives you 126 different alphanumeric characters and special symbols in four sizes and upper and lower case. You can rotate them, italicize them or change their intensities.

**You Need Speed.** The 280 can give you an average of 33,000 continuous lines or 200,000 points per second. It can display alphanumerics faster than fifty high-speed mechanical line printers working full time.

**You Get Computer Time.** The 280 operates at computer speeds. Requires minimum computer time. Moreover, it has its own special addressable, buffered memory that can store programs, process repetitive data and refresh displays, taking a sizable workload off the computer.

**Ease of Use.** Proper hardware design not only offers flexibility, but eases programming chores as well. You can use familiar languages, such as FORTRAN. And, typewriter keyboards, light pens, function keys and trackballs are available to help with the hard work.

**Like More Information?** We've got it. All we need is your letter or phone call, asking for it. Dept. LL 96.

DATA DISPLAY DIVISION **CONTROL DATA**  
CORPORATION  
PHONE: (612) 631-0550  
2401 NORTH FAIRVIEW AVE., ST. PAUL, MINNESOTA 55113

# YOKE SPECIALISTS

COMPLETE LINE for every Military and Special Purpose in PRODUCTION QUANTITIES or CUSTOM DESIGNED to your specific requirement.

- Yokes for all 3/8", 1 1/8", 1 1/2" and 2 1/8" neck dia. CRT's—only a few representative types are illustrated.
- Core materials to suit your requirements.
- Special test instruments can establish your yoke deflection parameters to an accuracy of ±0.1%.
- Special designs for color displays.
- Yokes available with series aiding field design or with parallel (bucking) field design.



Types V21 & V22

**VIDICON YOKES & FOCUS COILS** for 1" Vidicons IN VOLUME PRODUCTION NOW. For both commercial and military applications. Engineering Service available. Special designs for all types of 1" vidicons including electrostatic focus magnetic deflection types. For full technical details request catalog page.



Type P7



Type P8

**ANTI-PINCUSHION DEVICES,** both PM and EM types  
Eliminates CRT geometrical picture distortion. Type P7 permanent magnet anti-pincushion assembly requires no current... occupies small space... easily adjustable... mounts directly on standard yokes... available in wide choice of magnet strengths with tight tolerances. Type P8 electromagnetic coil anti-pincushion assembly has very high precision construction... allows convenient front panel adjustment. For full technical details request catalog page.



Type Y69

**TWEETER YOKE** for 1 1/2" neck dia. CRT's. For generating characters in alpha numeric displays. Matches solid state circuitry. Eliminates electrostatic middle plates. Frequency response up to 10 mc with a Q of 15. For full technical details request catalog page.



Type Y58 Series  
Up to 40°, 52°, 70° and 90° deflection angles.

**STATOR YOKES** for 1 1/2" neck dia. CRT's. For time shared sweep displays and other stator yoke applications. Available with high efficiency push-pull windings.



Type Y65  
Up to 70° deflection angle

**MINIATURE PRECISION ENCAPSULATED PUSH-PULL YOKE** for 3/8" neck dia. CRT's. Available in wide range of impedances and windings for both transistor drivers and vacuum tube circuits. Features electrically balanced windings with equal deflection sensitivities. Close angular tolerances of the display are achieved by precise construction. Epoxy encapsulated to withstand extreme environments. For full technical details request catalog page.



Type Y25-R Series  
Up to 52° and 70° deflection angles

**COMPACT ROTATING COIL YOKES** for 1 1/2" neck dia. CRT's. For Radar Plan Position Indicator and all other rotating coil applications. Versions available with dc off-centering coils. Complete in aluminum housing containing deflection coil, slip rings and brush assembly, drive gear and bearing for easy installation into any equipment design. Only 3 1/4" OD x 2 1/4" long. For technical details request catalog page.



Type Y15 Series  
Up to 52°, 70° or 90° deflection angles

**PUSH-PULL OR SINGLE ENDED YOKES** for 1 1/2" neck dia. CRT's. For military and oscilloscope applications requiring maximum resolution, low geometric distortion and high efficiency. Square core design with parallel opposed magnetic field. Available with extremely sensitive windings. For full technical details request catalog page.



Type Y16-6  
Up to 60° deflection angle

**HIGH SPEED PUSH-PULL YOKES** for 1 1/2" neck dia. CRT's. Ideal for high speed data presentation and oscilloscope applications using push-pull circuits requiring exceptionally high deflection rates, low distortion and high efficiency. Available with medium to very low impedance coils. Low stray capacity. Series magnetic field design. For full technical details request catalog page.



Type Y66  
Up to 60° deflection angle

**LARGE I.D. YOKES** for 2 1/8" neck dia. CRT's. Designed especially for character CRT's to give minimum twisting or distortion of characters. Suitable also for precision displays with other types of 2 1/8" neck dia. CRT's.



Type F10

**PRECISION ELECTROMAGNETIC FOCUS COILS** for 3/8", 1 1/8", 1 1/2" and other neck dia. CRT's. All designed for ultimate focus. Negligible effect on spot size when properly aligned to beam. Static types (all sizes)—low power or high power. Dynamic-static combinations (1 1/2" neck dia.)... compact single gap design... or double gap design to simplify circuitry by eliminating coupling between static and dynamic coils. Wide range of coil resistances available. For full technical details, request catalog pages. Please specify your CRT and beam accelerating voltage.

For engineering assistance in solving your display problems, please contact our nearest representative:

Boston-New England:	762-3164
New York:	695-3727
Philadelphia Area:	789-2320
Washington-Baltimore Area:	628-1023
Florida Area:	813, 347-6183
Los Angeles:	283-1201

**syntronic** INSTRUMENTS, INC.  
100 Industrial Road, Addison, Ill. (20 miles west of Chicago), Phone (Area 312) 543-6444  
Specialists in Components and Equipment used with Cathode Ray Tubes



## Data Display Devices from Raytheon

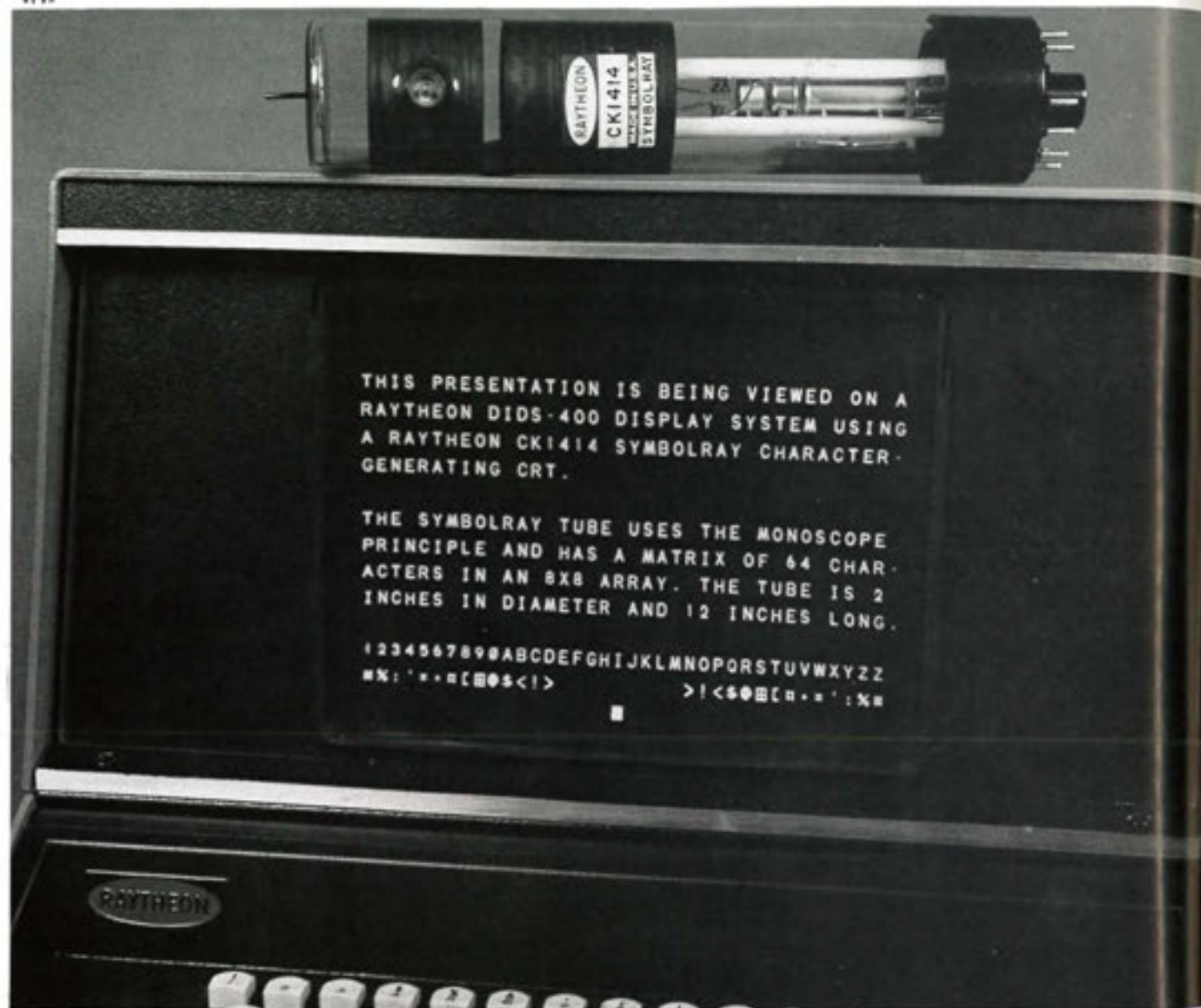

The presentation you see above was generated by a Symbolray\* Cathode Ray Tube identical to the one lying on the console. A new type of monoscope, the Symbolray can generate alphanumeric characters from electrical signals for cathode-ray display or for hard copy print-out. The presentation here is shown on a Raytheon tube (CK1415) used in a Raytheon DIDS-400 display system.

**An economical method of generating characters.** Priced at less than \$100 in quantities of 1,000, the Symbolray provides a more economical method of generating

electronic displays than using large numbers of circuit cards.

The output of the Symbolray operating as a monoscope is obtained by electrically deflecting the electron beam to desired characters on the target and scanning them sequentially with small raster. The display cathode ray tube on which this output is viewed is scanned in synchronism. When the Symbolray method is used in conjunction with buffer-memory techniques, full messages can be displayed—as shown above. The Symbolray tube uses electrostatic deflection and

focus, and is available in designs with 64 and 96 character matrices.

**Raytheon's wide range of Data-ray\* CRTs** cover the screen sizes from 7 to 24". Electrostatic, magnetic and combination deflection types are available for writing alphanumeric characters while raster scanning. Raytheon also offers combination deflection or "diddle plate" types and all standard phosphors. Or, Raytheon can meet your special CRT design requirements.

For more information—or a demonstration—call or write your Raytheon regional sales office.



**New Raytheon Projectoray\* Tube** produces more than double the light output of standard projection-type cathode ray tubes. The tube's light output is 38,000-foot lamberts, which results in a light level of 15-foot lamberts on a 6' x 8' lenticular screen.

The tube's expected minimum operating life is 500 hours—20 times the life of a standard projection tube.

The Projectoray's high light output and long life are due to its novel design. The design incorporates liquid cooling of the phosphor backplate. This allows the phosphor to be energized with a very intense electron beam. At high beam levels, very high peak light output is obtained. The light image is projected through a 5" optical window in the face of the tube. The electron gun is set at an angle to the phosphor and the deflection system compensates for keystone effects.



**Datavue\* Side-View Tubes.** New Type CK8650, with numerals close to the front, permits wide-angle viewing. These side-view, in-line visual readout tubes display single numerals 0 through 9 or preselected symbols such as + and - signs. Their 1/4"-high characters are easily read from a distance of 30 feet. Less than \$5 each in 500 lots, they also cost less to use because the bezel and filter assembly can be eliminated and because their mating sockets are inexpensive.



**Datastrobe\* EM7 Readout Subsystem** can display up to 60 messages (in characters, symbols, and schematics) at a cost of less than \$5 per message, when purchased in production quantities.

These messages can be one line of eight to ten characters, two lines of 40 characters, or three lines of 105 characters. A typical display area measures 1/2" high by 2 1/4" wide. Model EM8 Datastrobe has twice the display capacity—can display 120 messages, either singly or two messages simultaneously. Other formats are easily accommodated.

A complete digital readout subsystem compatible with integrated circuits, the Datastrobe includes decoding, driving and display functions.



**Recording Storage Tubes.** The miniature tubes shown here are Raytheon's single-gun (CK1516) and dual-gun (CK1519). They provide high resolution, long storage, and fast erase capability.

Raytheon electronic input-output storage devices feature the above capabilities and immediate readout. Information can be written and stored by sequential techniques or by random-access writing. Complete, gradual or selective erasure is possible.

Raytheon storage tubes are readily available for applications in radar scan conversion, slow-down video, signal processing, signal enhancement, time delay, and stop motion.



**Datavue\* End-View Tubes.** These tubes are easily read in high ambient light—do not wash out like other displays. Erroneous readings due to segment failure do not occur because the characters are fully formed. Raytheon Datavue End-View Tubes fit existing sockets and conform to EIA ratings. Models include round (CK8421) and rectangular (CK8422). Ultra-long-life types are designed for 200,000 hours or more of dynamic operation.



Send Reader Service Card for literature on the:

Symbolray CRT	13
Projectoray CRT	14
Recording Storage Tubes	15
Datastrobe Readout Subsystem	16
Datavue Indicator Tubes	17
Dataray CRTs	18

Or call your Raytheon regional sales office. Or write to Raytheon Company, Components Division, 141 Spring Street, Lexington, Mass. 02173.

\*Trademark of Raytheon Company



**Raytheon Components Division—A single source for Transistors/Diodes/Integrated Circuits/Industrial Tubes/Control Knobs/Panel Hardware/Raysistors/Circuit Modules/Display Devices**



10 SECONDS

FROM DATA TO LARGE SCREEN PRESENTATION

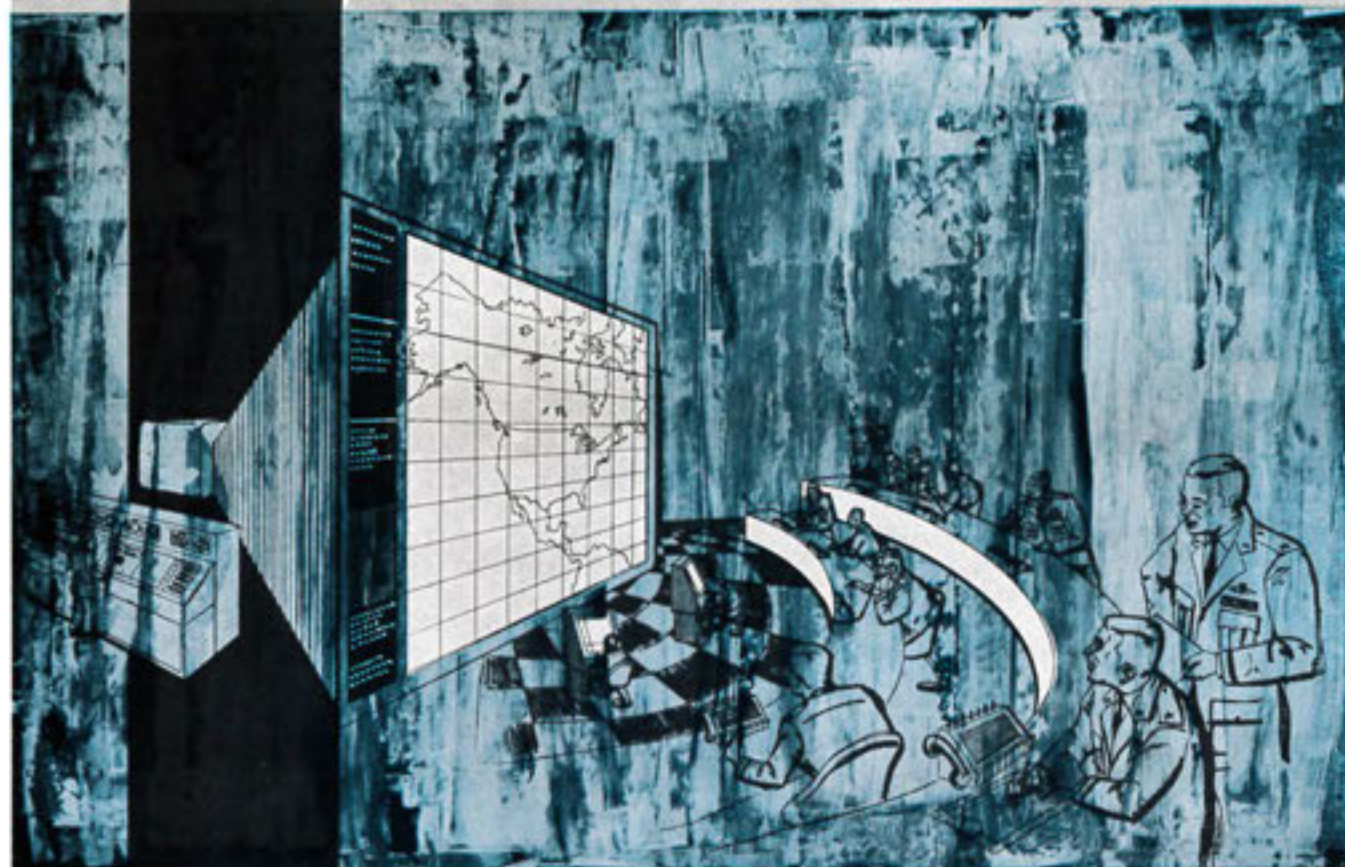

## Full color data display with OPTOmechanisms rapid access processor/projection system

Only 10 seconds from computer to full color data display—front or rear projection. This advanced OPTOmechanisms' rapid up-date system delivers vital data for Command and Control Centers on theatre size screens with a symbol brightness of over 20 foot lamberts. The system processes film images by direct reversal and provides extremely high resolution presentations, at short throw distances, for group viewing. No dark room is required. OPTOmechanisms' compact Camera-Processor-Projector is completely self-contained and self-programmed. A fully detailed bulletin of this unique data display system is available.

### BLACK AND WHITE CAMERA/PROCESSOR/PROJECTOR

OPTOmechanisms' black and white data display systems feature negative or direct positive film processing with a resolution range of 50-80 lines per mm. These compact, flexible, and fully self-contained systems record, process and project data in only 8 seconds. They are easily integrated with electronic sub-systems. Typical applications: data and instrumentation display, radar, air traffic control, radiological and other medical applications.



PATENT NOS. 2,981,170 and 3,115,079

**OPTOmechanisms Inc.**

ENGINEERS HILL, PLAINVIEW, L. I., N. Y. • (516) GE 3-8100 TWX: CODE 516-433-9690

SPECIAL CAMERAS — PHOTOMETRIC DEVICES — OPTICAL TACHOMETERS — RAPID FILM PROCESSORS — PROJECTORS — OPTICAL TRACKERS  
STEREO VIEWERS — SATELLITE DETECTORS — MEASURING INTERFEROMETERS — STEREO COMPARATORS — LINEAR MEASURING TABLES  
STAR SIMULATORS — NEGATIVE TO POSITIVE FILM VIEWERS — ANGLE GENERATORS — FIBER OPTICS APPLICATIONS — RANGE FINDERS

# Pens belong in drafting...

## *not in Plotting!*

Geo Space's revolutionary DP-203 Digital CRT Plotter uses a CRT's electron beam for plotting. Does away with messy ink receptacles and skipping ballpoint pens. An electron beam positions up to 96 million plotted data points over an entire 2400 sq. in. surface to within  $\pm 1/2$  bit. That's  $\pm .0025$  of an inch in the 200 dppi plotting mode. Match that accuracy with a pen plotter!

Do you require multiple copies of any plot you produce? The positive film images of the Geo Space DP-203 CRT Plotter can be used to produce multiple Ozalid or Xerox copies at a cost of only pennies apiece.

On-line plotting is now a practical, economic reality. Gone are the separate core buffers and controllers of yesteryear.

Using Geo Space furnished ALPACA® linkage software, you can produce detailed contour or cartographic maps, electronic schematics, PERT charts, tabular charts, annotated drawings and the like. One-pass annotation to describe and label your primary images.

Another important benefit—up to 32 levels of intensity shading can be program selected to enhance the tonal contrast of your completed imagery. Background area shading also.

Want more information on the most advanced plotting peripheral available today for digital computers? Write or call Geo Space Corporation, Computer Division, A Subsidiary of Westec Corporation, 3009 South Post Oak Road, Houston, Texas 77027. Telephone: 713/NA 2-4570.



**GEO SPACE**  
COMPUTER DIVISION

# IBM announces direct-access files for SYSTEM/360 Model 20



Now, the lowest-priced IBM SYSTEM/360 gives you a level of performance never before possible in a low-cost system.

IBM's Model 20 provides direct-access capabilities with the simple addition of the 2311 Disk Storage Drive... in two models similar to the high-performance drives previously available only with larger models of SYSTEM/360.

The 2311 features on-line storage of up to 10.8 million bytes; access times as fast as 60 milli-

seconds; a data transfer rate of 156,000 bytes per second; and interchangeable disk packs.

If you are a Model 20 user, the 2311 means you can handle a much broader range of business applications.

You can use systems approaches that let you reach into the system and select any record vital to the control of your company. You can call for on-the-spot management information... and get it in seconds.

Moving up to a Model 20 disk system is made easier with IBM's Report Program Generator, a proven programming language that will be expanded to support disk and disk-tape systems.

And you can add this dimension of direct access to your Model 20 for as little as \$575 a month.

What better way to have a computer system keep pace with your company's growth?

SYSTEM/360 was designed that way.

**IBM**

Circle Reader Service Card No. 21

INFORMATION DISPLAY, SEPTEMBER/OCTOBER, 1966



**WHAT'S  
HAPPENING  
HERE**

**SEE THE  
ANSWERS  
DISPLAYED  
CLEARLY,  
CONCISELY,  
COLORFULLY  
WITH  
TEC-LITE**

**DATA · PANEL**  
DISPLAY SYSTEMS



Northern States Power Company



The Mitre Corporation



Louisiana Power & Light Company



ASI Computer Division,  
Electro-Mechanical Research, Inc.



Univac  
Division,  
Sperry Rand  
Corporation



TRW Systems

**VERSATILITY**



### SEE WHAT'S HAPPENING... SOLVE MAN-MACHINE COMMUNICATION PROBLEMS

DATA • PANEL Display Systems convey information clearly and concisely with graphic versatility never before available. You get a new world of freedom in styling and panel layout... information on display with an entirely new look. Alpha-numeric messages and symbols are brilliantly visible behind planes of glare-free graphic gray glass. Only illuminated indications are visible. Operators are not confused by the visual presence of non-indicating indicators—they suffer less visual fatigue, make fewer errors.

Only the DATA • PANEL Display System concept can give you such latitude in selecting the size, shape, color and location of messages... and of overall dimensions. DATA • PANEL Display Systems can be custom designed as a complete electronic assembly ready to operate (via multi-pin connectors) from the signal voltages of any analog, digital or hybrid system. Switches, in a wide variety of types and actions can be mounted in the panels as an integral part of the DATA • PANEL Display System. Write for new, full story brochure, specifications and ordering information.

Here's proof of visual clarity: Designed for the GP-4 Digital Computer of General Precision Inc's. Link Group, this DATA • PANEL Display System has 469 separate message displays. But, the operator sees only the important illuminated messages. Permanently visible legends (lower half of panel) can be provided as desired. This panel also includes readouts and pushbuttons for alternate, momentary and interlock switches.

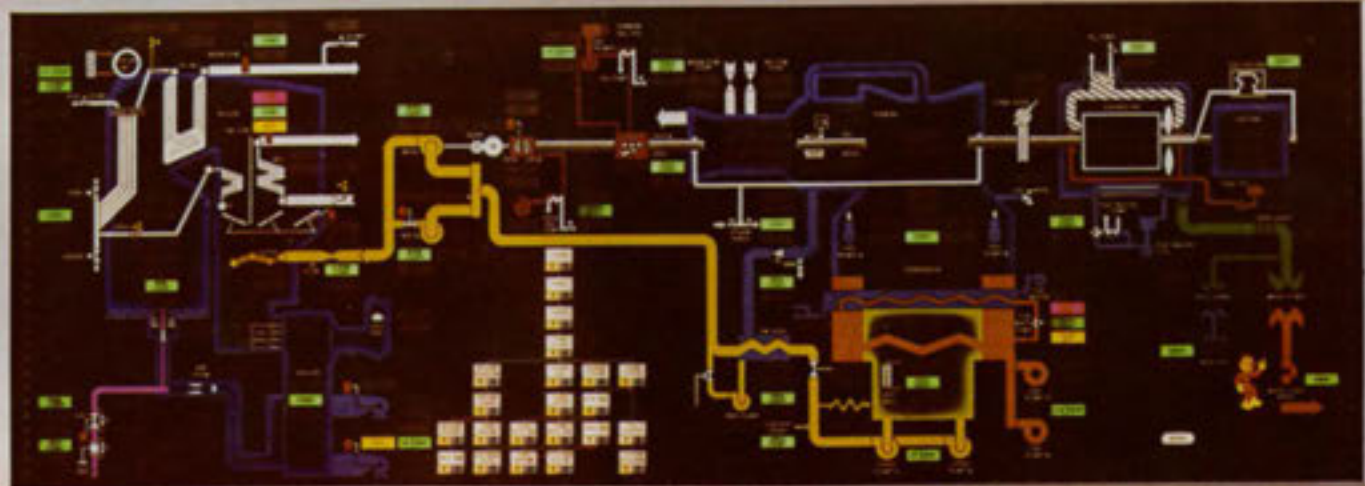

Here's proof of visual versatility: At Little Gypsy Power Plant of Louisiana Power & Light Company, all phases of a steam generating plant monitoring system are pictorially displayed on one large panel... from

gas input, left, to main load breaker, right. Status reports, invisible when off, appear in color in boxes located at appropriate points on the panel. Pictorial displays and symbols are permanently visible.

**TEC-LITE**

**DATA • PANEL**

DISPLAY SYSTEMS



**Transistor Electronics Corporation**

Box 6191 Minneapolis, Minnesota 55424

Circle 4 On Reader Service Card

School principals study a United Fund agency that provides the handicapped with both vocational training and work.



Attorneys, members of a United Fund campaign committee, visit an agency that helps youth, the aged and the needy.

Union leaders chat with a child being helped by rehabilitation, nursing and other United Fund services.



An industrialist inspects an agency that provides a "day camp" for children of working mothers.



Bank presidents call on a family whose three children were adopted through an agency of the United Fund.



## Your Fair Share Gift is insured

When you contribute your fair share to your local United Fund or Community Chest campaign, you can be certain that your gift will be handled in a business like manner.

Business, labor and the professions are strongly represented among the volunteer community leaders who visit participating agencies before each campaign to study their programs, performance and value to the community.

To these volunteers, a United Way dollar looks like one of their own, to be budgeted, allocated and spent where it will accomplish the most good. Their active interest in both the humanitarian and business side of United Way operations is your assurance that your United Way gift will truly work many wonders.

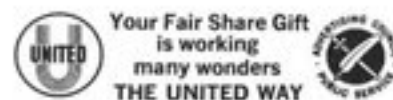

25 million families benefit by child care, family service, youth guidance, health programs, disaster relief and services for the Armed Forces from 30,000 United Way agencies.

# Multi-Sensor Displays— Two Approaches

## Abstract

The display of signals from two or more information-gathering sensors on a single monitoring device has become an increasing problem in military detection and surveillance systems. During the past year, RCA has made a concentrated study of the basic functional requirements of multi-sensor display systems, and has also observed carefully the development of prototype multi-sensor systems which utilize RCA devices and those of other manufacturers. Simultaneously, analyses were made of the performance capabilities of the different classes of display devices which relate to the basic functional requirements of such display systems. This report reviews the results of these analyses.

## General Requirements

Such requirements of multi-sensor display systems as display luminance, resolution, ruggedness, and weight conservation are assumed to be essentially identical to those of single-sensor display systems currently used in high-performance aircraft. However, the multi-sensor display systems differ quantitatively from the single-sensor display system in that the time required to synthesize a complete frame may vary widely as the different sensors are interrogated by the command of the observer. The multi-sensor system, therefore, must have the capability of variable image persistence. This persistence must be readily programmed to be consistent with the data rate of the sensor system being monitored at any given time. The range over which image persistence must be programmable depends upon the mix of sensors being monitored. A typical multi-sensor display system may require modes of operation as tabulated below. For each mode, a qualitative measure of the persistence required is noted.

Mode	Persistence
Terrain avoidance (shades of gray)	Medium
Terrain following (E-scan)	Medium
Flight situation (contact analog)	Short
B-scan radar	Long
LLTV	Short
PPPI (terrain-mapping) radar	Long
Infrared	Medium

For short-persistence modes, it is taken for granted that the frame rate exceeds the flicker-frequency-threshold of the human eye. It is assumed, also,

by M. D. Harsh

Electronic Components and Devices  
Radio Corporation of America  
Lancaster, Pennsylvania

that the display format in these cases is approximately that adopted as standard in the TV industry, i.e., rectilinear raster scan line rate = 15,750 Hz; frame rate = 30 Hz; interlace ratio = 2:1. The medium- and long-persistence modes are assumed to involve frame periods between 0.5 second and 20 seconds.

Two possible solutions to the multi-sensor display problem are as follows:

1. An approach in which the ultimate display device is a storage tube which has a programmable persistence: short enough on the one hand to accommodate TV data rates (a few milliseconds) and long enough on the other hand to present radar data (several seconds). This procedure is identified in this report as the Display-Storage Tube (DST) approach.
2. An approach in which signals in the short-persistence modes, where data rates approximate those of standard TV systems, are applied directly to the ultimate display device. The ultimate display device in this case is a cathode-ray tube providing high brightness. Signals from sensors requiring long or medium persistence, however, should be converted to a TV time base for display on the cathode-ray tube. An appropriate converter is the Scan-Conversion (electrical-output) storage tube. This method is identified in this report as the Scan-Conversion/Cathode-Ray Tube (SC/CRT) approach.

It is evident that the SC/CRT approach requires an additional tube and associated circuits. It is equally evident that final choice between these two

systems cannot be made without a systematic review of the less obvious performance characteristics of these two different approaches.

## Outline of Analysis

The success of a multi-sensor display system for many weapons systems depends upon the ability of the ultimate display device to present to the observer a high-quality, TV-type picture in at least one and possibly several modes of operation. This report, therefore, begins with a *Comparison of DST's and CRT's as TV Display Devices*. Because it is equally important that the longer-persistence operating modes present a maximum of information to the observer, a *Comparison of the DST Approach with the SC/CRT Approach in a PPI Display System* follows. In the *Summary*, these comparisons are briefly evaluated and appropriate conclusions drawn.

## Comparison of Display-Storage Tubes (DST's) and Cathode-Ray Tubes (CRT's) as TV Display Devices

For comparison purposes, a tube in each classification was hypothesized and the following parameters fixed:

Nominal diameter	.....7 inches
Neck diameter	.....7/8 to 1 inch
Phosphor screen voltage	.....15 kilovolts
Phosphor screen current	.....500 microamperes
TV raster aspect ratio	.....3:4
Deflection method	.....Magnetic
Phosphor color	.....Yellow-green

A P20 phosphor was chosen for the DST screen. The phosphor used in the CRT screen was a developmental type, better suited to handle high instantaneous current densities associated with this class of tube. This developmental

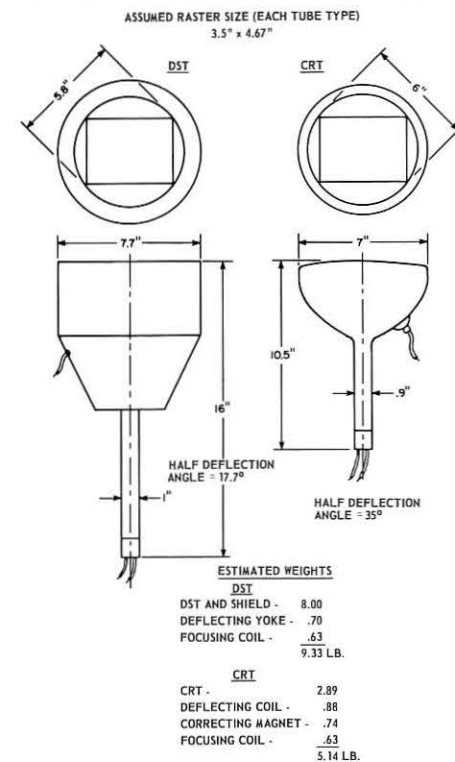

FIGURE 1: Weight and size comparison of DST and CRT.

phosphor, like the P20, provides yellow-green luminescence but has a higher red component.

The other parameters selected for each class of device, such as focus method, deflection angle, and over-all length, were considered appropriate and reasonable.

Most performance values for the CRT were taken directly or extrapolated from measurements and calculations made expressly for this analysis. For the DST, some data were obtained from measurements of RCA tubes, some from published data offered by other manufacturers for DST devices. Resolution information was extrapolated from data contained in *Phase II Summary Developmental Report for Research and Development to Improve the Resolution of Iatron Direct View Storage Tubes*. This summary covers work conducted by ITT from March 2, 1964 to June 2, 1965 on Navy BuShips Contract NObsr-87264 SF-00803, Task 9487.

Information in this report, therefore, represents a judgment on the state-of-the-art for both classes of devices. As both arts are relatively mature, any basic improvement in the performance levels discussed later are unlikely, unless unforeseen invention occurs. Finally, every effort was made to make the assumed conditions of evaluation consistent, e.g., the conditions from which the luminance values were derived are consistent with the conditions from which resolution values were derived.

## Size and Weight

The over-all dimensions of the DST and the CRT are shown in Fig. 1 together with estimated tube weights and the weight of necessary shielding and externally mounted components. The relatively high beam voltage employed by the CRT is assumed to obviate the need for complete magnetic shielding; however, a neck shield should be used for this tube. The estimated weight of a suitable electromagnetic focusing coil for the CRT, 10.63 lb., is included in Fig. 1; the electrostatic focusing device, mentioned elsewhere, weighs less.

Both the DST and the CRT have been successfully ruggedized for use in military aircraft. The CRT, because of its simpler structure, is generally more rugged.

## Power Consumption

Because of the DST's smaller deflection angle and lower electron-beam velocities, the DST deflection system can be made to require substantially less power than that of the CRT. (The equipment manufacturer can best estimate the power requirements of the deflection circuits for the two types of tubes.) In general, the total power consumption for a CRT-type TV monitor is in the range of 50 to 100 watts.

Estimated power consumption of the two types of tubes, excluding circuits, is as follows:

DST	
Flood heater	11.30
Flood grid 1	0
Flood grid 2	0.05
Flood grid 3	0.01
Flood grids 4, 5, and 6	0
Collector	0.04
Viewing screen	7.50
Write heater	1.90
Write grid 2	0.40
Write focus coil	0.40
Total	21.60 watts
CRT	
Heater	1.90
Grid 1	0
Grid 2	0
Grid 3	1.05
Anode	7.50
Total	10.45 watts

## Pattern Geometry

Because the display picture is presented on an essentially flat surface, some pincushion distortion can be expected. A measure of this distortion is the extent to which the sides of a nominally square raster, with corners just inscribed within the useful area, bow inward. For the DST which is assumed to have a half-deflection angle of 17.7°, this bow is about 0.038 inch. For the CRT which is assumed to have a half-deflection angle of 35°, the bow is about 0.055 inch.

Pincushion distortion can be reduced through modification of the deflection yoke. However, yoke modification can reduce over-all resolution. Another method of reducing pattern distortion requires the use of static correction magnets. Although this approach is satisfactory for CRT displays, it is not recommended for DST displays, because magnets severely distort the flood-beam collimation fields.

## Luminance (Brightness)

DST's have been typically rated in terms of saturated or equilibrium luminance. This rating is the luminance level to which the phosphor screen is excited when the storage mesh is "written" to a potential sufficiently close to the flood-cathode potential. This condition indicates that conduction of flood-beam electrons to the phosphor screen is at a maximum. This concept does not apply to CRT luminance because a properly-operated CRT does not exhibit luminance saturation in an equivalent sense. (See the section on *Transfer Characteristics*.) However, to allow at least a rough comparison, the CRT luminance was calculated by assuming that its screen (beam) current was equal to the DST screen current under conditions of saturated brightness. A value of 500 microamperes was assumed to be reasonable. The following luminance values

were obtained:

DST	CRT
1450 footlamberts	1030 footlamberts

The apparent luminance advantage of the DST must be evaluated properly. In practice, considerations of display quality (resolution and gray-scale reproduction) probably will require that the operating level of the DST is set substantially below that of the saturated luminance. Therefore, the systems analyst must weigh the apparent luminance advantage of the DST with other evidence presented in this report, particularly in the sections on *Resolution* and *Transfer Characteristics*.

## Resolution

The term "line-width," is defined in Fig. 2. Line-width may be measured approximately by the shrinking-raster technique or, somewhat more objectively, by the use of a slit photometer to inspect luminous-flux-density distribution across a displayed trace. If the stated luminance level is assumed to be 50 per cent of the luminance values given above, reasonable line-widths at

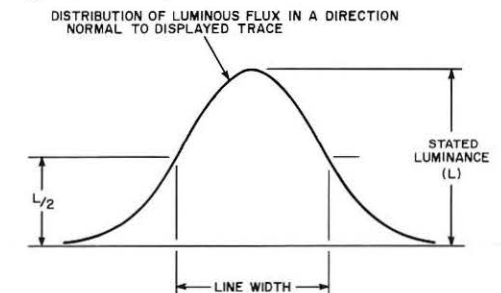

FIGURE 2: Definition of line width as used in the paper.

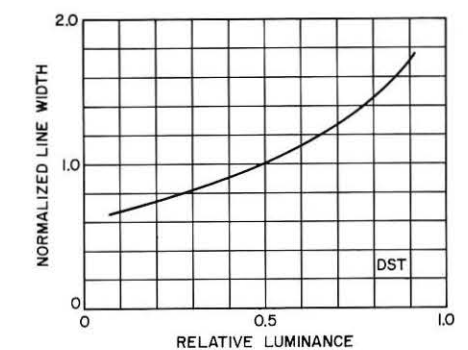
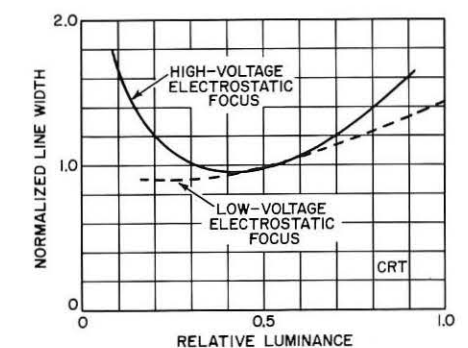

FIGURE 3: Line-width change as a function of luminance.

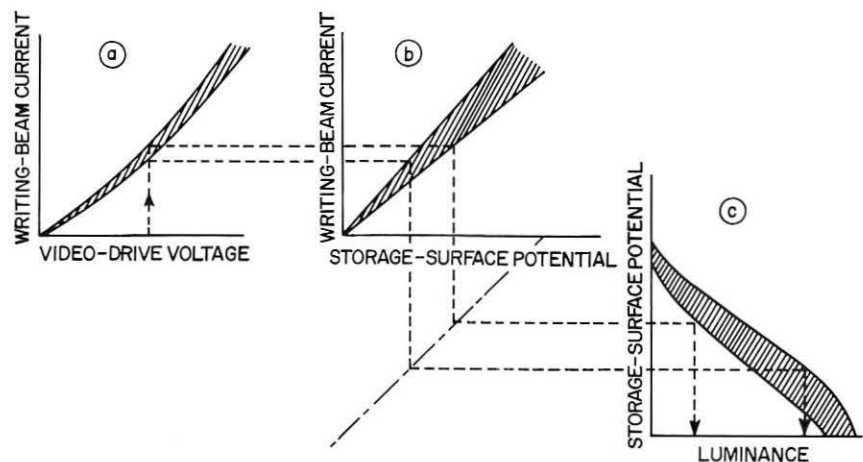

FIGURE 4: Factors contributing to point-to-point nonuniformities in over-all transfer characteristic of DST.

the center of the display are as follows:

DST	CRT
0.012 inch	0.007 inch*
	0.012 inch**

\*Using high-voltage electrostatic or magnetic focus lens.  
 \*\*Using low-voltage (unipotential) electrostatic focus lens.

For completeness, it is also necessary to indicate the order of magnitude of line-width degradation as the electron beam is deflected to the edge of the display. The following values are estimates of the ratio of line-width at the edge to line-width at the center. In each case, dynamic focus corrections are assumed.

DST	CRT
1.25:1	1.5:1

Finally, the change in line-width as a function of luminance level to which the display is driven must be considered. As shown in Fig. 3, the line widths have been normalized to the value measured at a relative luminance level of 0.5.

#### Uniformity

Provided that the input signal is constant in the CRT, point-to-point uniformity of display luminance over the display area is controlled, for all practical purposes, by the uniformity of the phosphor screen and its backing aluminum layer. Measurements indicate that a typical ratio of maximum luminance-to-minimum luminance is 1.17:1.

The factors which influence uniformity in the DST are considerably more complex. An understanding of these factors may be obtained by reference to the series of transfer curves in Fig. 4. Curve 4a shows the writing-beam transfer characteristic. Writing-beam current denotes the current actually reaching the storage surface plane. Thus, writing-beam current may vary from point to point at the storage surface because of variations in electron transmission of the collector mesh.

sion of the storage mesh and the distribution of current density in the flood beam delivered from the flood gun through the collimation system. Although it cannot be illustrated by a set of static characteristics, translation of the characteristic exists as a result of differences in levels to which preceding erasing events have charged the storage surface. No attempt has been made to indicate the magnitude of variations to be expected in the individual transfer functions shown. Control of the factors which influence point-to-point variations in the over-all transfer characteristic of the DST is substantially more difficult than in the case of the CRT.

Fig. 5 shows the variations in the

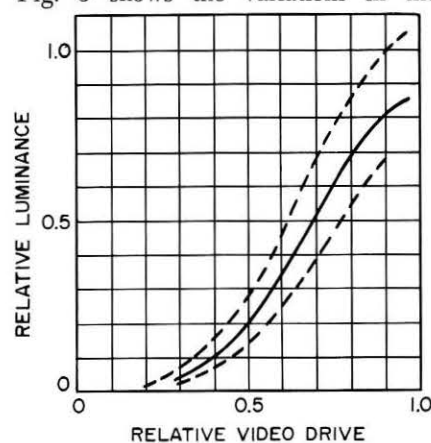

FIGURE 5: Measured point-to-point nonuniformities in over-all transfer characteristic of a typical DST.

Curve 4b shows the transfer characteristic that relates the magnitude of charge developed on the storage surface to the incident beam current. For a fixed scanning speed, the slope of this characteristic depends upon the beam diameter, the thickness of the insulator, the dielectric constant of the insulator, and the secondary-emission ratio of the insulator. All can vary with position on the storage surface.

Curve 4c shows the transfer characteristic of the storage mesh on which the insulator is deposited. The slope of the characteristic depends upon transmission of the storage mesh, the thickness of the mesh, and the arrangement of adjacent elements (collector and viewing screen). The intercept of this curve on the luminance axis depends upon the transmis-

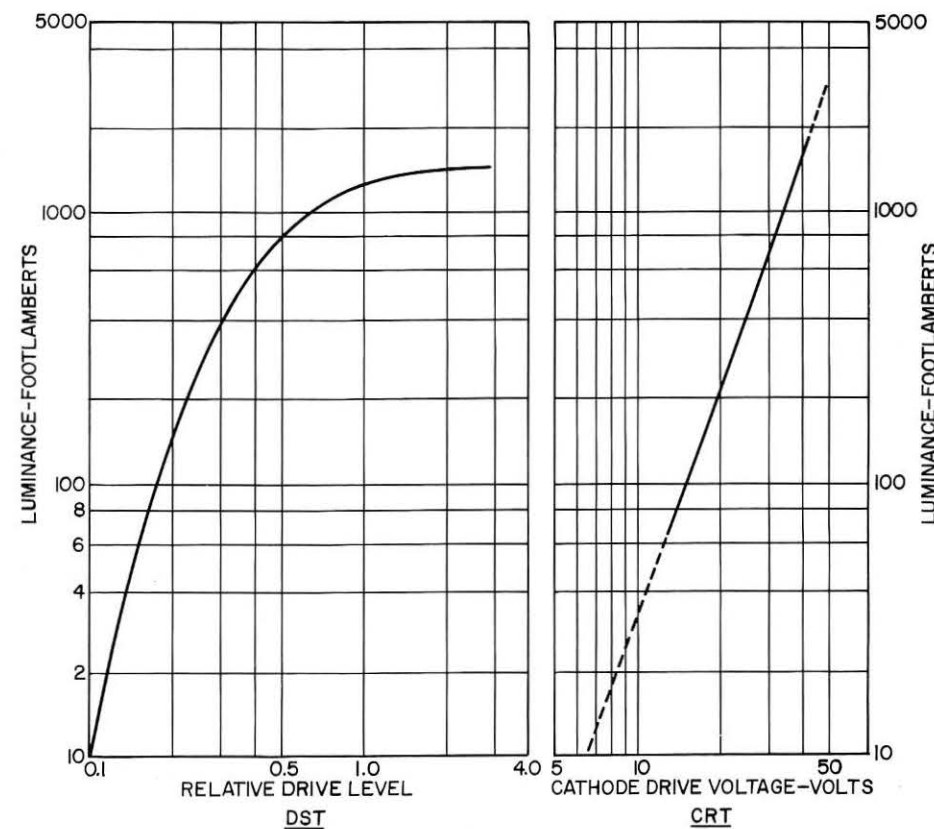

FIGURE 6: Over-all transfer characteristics.

over-all transfer characteristic, measured at several points on the useful display area of a typical high-quality DST. The luminance ratio varies with the level of the input signal, but it may be taken to be at least 1.5:1.

#### Transfer Characteristic

In television-system design, the transfer characteristics of the associated components are vital. The camera tube, the amplifier channel, and the display device must have transfer characteristics that are complementary if relative scene luminances are to be preserved in a controlled fashion in the final display. The gamma of a camera tube is typically less than unity. As shown in Fig. 6, however, the gamma of a CRT is greater than unity. Thus, the gamma correction of the intervening amplifier channel may be relatively modest and, in fact, may not be necessary in some instances. However, the transfer characteristic of the DST exhibits a gamma that varies with luminance level, and falls to a low value as saturated luminance is approached. Therefore, because the gammas of the camera tube and the DST are not complementary over a significant range, amplifier gamma correction becomes difficult if the amplitude of the camera output signal varies as a result of changes in the illumination of the scene being televised. The shape of the DST transfer curve also illustrates why, in practical situations, the operating luminance level usually is well below saturated luminance level. This condition results, in part, from the excessive video-drive voltage necessary to attain luminance levels above 75 per cent of saturation.

#### Erasing

Erasing is not required with the CRT because picture information is automatically cleared by the natural decay of phosphor luminance following excitation. Erasing in the DST can be accomplished with a programmed sequence of erasing pulses, usually applied during the field-flyback interval. Although such erasing is relatively straightforward in principle, it can be complicated by a number of factors in practice.

First, the nature of the erasing characteristic should be considered. Fig. 7a shows such a characteristic for erase pulses having an amplitude equal to the cutoff potential of the storage-mesh transfer characteristic. Although the length of the erase pulse necessary to achieve 80-per cent clearance of previous information is relatively short, the clearance of the remaining 20 per cent takes considerably longer. Also, erase pulses of this amplitude tend to result in a reverse-image effect. Accordingly, the usual practice is to employ an erase-pulse amplitude somewhat higher than the value that just produces storage surface cutoff (a mode sometimes called

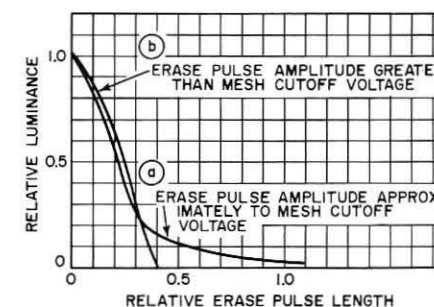

FIGURE 7: Typical DST erase characteristic.

erasing "blacker-than-black"). This erase characteristic is shown in Fig. 7b. The practice, however, tends to intensify mesh-interference moire effects. In general, the adjustments necessary to achieve an erasure that avoids image smear interact with the adjustment of writing video-drive and bias, and thereby complicate adjustment of the DST.

Second, the bright flash which accompanies each erase pulse must be suppressed. In the usual DST, this suppression involves "dunking" the high voltage applied to the viewing screen to two or three kilovolts. Because of the stray capacitance of the viewing screen, it is highly desirable that the individual erase pulses should be as long as possible. This condition usually leads to erasure during the field-flyback interval. Two objections to this practice are evident: (1) display luminance tends to decrease from the top of the picture to the bottom, because the time over which luminous flux is integrated by the observer's eye is greater for the earlier lines in the TV field than for the subsequent lines, and (2) the field-flyback interval cannot now be used to prevent symbology as is desired in some systems. The "dunking" voltage swing can be reduced greatly by the addition of an electrode to the tube for this purpose. The "dunking" pulse rise time can be reduced, therefore, without excessive expenditure of power. Yet, while the additional electrode, which is a mesh screen, enables more flexible erasing routines, it also increases the possibility of moire effects, decreases tube ruggedness, and increases tube cost.

#### Ease of Setup

Adjustment of the DST is more complicated than adjustment of the CRT. Proper collimation of the flood beam, which is critical in attaining optimum display uniformity, is of particular concern. Improvement in this area is offered by factory-collimated DST's. In these tubes, the manufacturer encapsulates part of the collimation circuit within the tube-magnetic-shield interspace after adjusting the collimation to an optimum level. This practice removes the burden of collimation from the frequently-unskilled field maintenance technician.

#### Operator Adjustments

The operator usually controls display

luminance in DST indicators by manually rotating a crossed Polaroid<sup>®</sup> filter assembly. An alternate control method is to adjust the high voltage applied to the viewing screen. This method should be avoided, however, because the change of viewing-screen voltage tends to interact with and disrupt previous adjustments for optimum resolution, optimum writing, and erasing balance. Controls for the adjustment of writing-gun bias, focus, and video-drive voltages are usually not available to the pilot because of their critical nature.

In an indicator using a CRT, it is possible to provide these controls because adjustment for optimum display performance, including luminance level, is no more critical than for the familiar entertainment TV set. Although military practice usually demands a minimum of controls, there is the psychological advantage of offering these three adjustments to the pilot who then has a sense of control over the data being presented to him.

#### Summary

In terms of general display quality (as affected by resolution, uniformity, transfer characteristic, and similar characteristics), the CRT is a more effective TV display device than the DST. Even with regard to output luminance, where the DST appears to have an advantage, there is considerable evidence to suggest that in practical operating situations this apparent advantage is not realized.

#### Comparison of the DST Approach with the Scan-Converter Cathode-Ray Tube (SC/CRT) Approach in a PPI Display System

To some extent, the details of a comparison study depend upon the type of radar display under consideration. In this report, display parameters are those of an offset sector PPI indicator, as shown in Fig. 8. In each case, the origin of the sector and the locus of maximum range are assumed to be tangent to the bottom and top, respectively, of the useful display diameter. The displayed sector occupies a total angle of 90° and

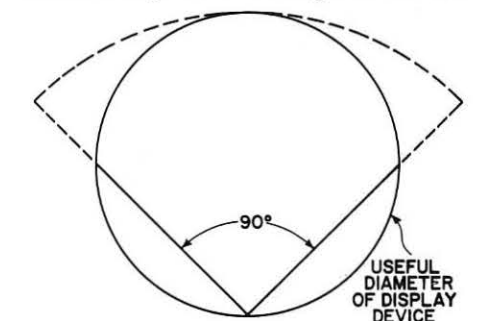

FIGURE 8: Assumed geometry of sector PPI display as used in the paper.

<sup>®</sup>Trademark of Polaroid Corporation, Cambridge, Mass.

is scanned at a rate of  $\frac{1}{2}$  Hz, i.e., the time to scan from left to right and to return is 2 seconds. Although this analysis does not involve range or radar PRF explicitly, both approaches are consistent with airborne radar practices.

In this comparison, the DST approach employs the seven-inch DST hypothesized in the preceding section. For the SC/CRT approach, a corresponding seven-inch CRT is used as the ultimate display device. The scan-conversion tube is the RCA Developmental Type C22001 Graphicon.

Other devices suitable for this purpose are the transmission-control (Recording) storage tube or the landing-control (Metrechon) storage tube, both of which offer capability of so-called nondestructive readout, i.e., very long storage times. The Graphicon was chosen for the following reasons:

1. Display system used in most high-performance aircraft do not require extended storage of images.
2. The Graphicon is inherently more rugged because it has fewer fine-mesh screens (one compared with three or four).
3. Both nondestructive readout types require normal incidence of the reading and writing beams, and therefore, are more critical to set up and to adjust for optimum performance.
4. The Graphicon can be made shorter for a given storage-target size, and thus for a given resolution.
5. The Graphicon does not require carrier-frequency techniques to prevent feedthrough of input-video signals to the output-pre-amplifier channel.

Block diagrams for the two approaches applied to a simple two-sensor display system (a TV camera and a radar receiver) are shown in Figs. 9 and 10. The need for two synchronizing generators in the SC/CRT is controlled by the compatibility of TV camera rates with those considered optimum for the scan-conversion process. This study assumed

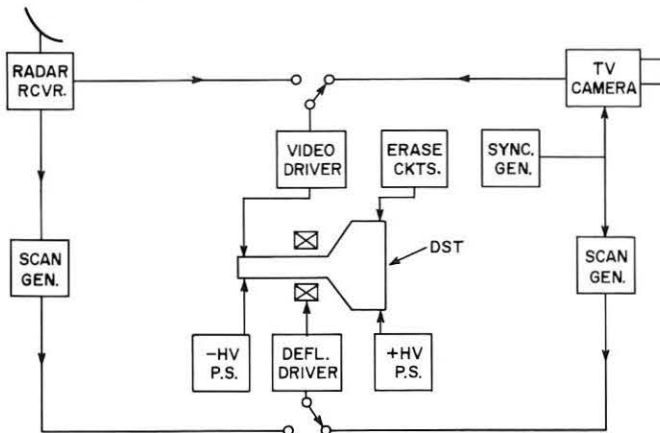

FIGURE 9: DST approach to multi-sensor display system.

non-compatibility in this respect, but a single synchronizing generator may be possible in other specific systems.

#### Size and Weight

The equipment manufacturer is best qualified to estimate weights and volumes of total systems for the two approaches. However, estimated weights for the tubes and intimately associated components are provided for guidance purposes. These weights appear in Fig. 1 for the DST and CRT, and in Fig. 11 for the SC (RCA-C22001). Outline dimensions for the C22001 encapsulated in a typical magnetic shield-support assembly are also shown in Fig. 11. Dimensions for the RCA Developmental C22007, a shorter tube, appear in Fig. 12 for comparison.

#### Power Consumption

Power consumption values are shown below for the SC alone. (Power consumption values for the DST and CRT were given previously.) The total system power consumption is best determined by the equipment manufacturer;

Heaters (2) .....	1.20
Control grids (2) .....	0
Writing grid 2 .....	0.03
Writing grid 3 .....	0
Writing grid 4 .....	0.01
Reading grid 2 .....	0.06
Reading grids 3 and 5 .....	0.01
Reading grid 4 .....	0
<b>Total .....</b>	<b>1.85 Watts</b>

#### Ruggedness

The RCA-C22001 Scan-Converter is rated for operation in modern high-performance fighter aircraft. This tube is inherently less rugged than a CRT because of its extra gun and the relatively fragile target, yet it is more rugged than the DST, which has an additional fine-mesh structure. Furthermore, the mesh structures of the DST are substantially larger in area and tend to have "drum-head" resonances in the frequency ranges encountered in aircraft vibration profiles.

The consequences of tube failure in the two approaches are of interest. In

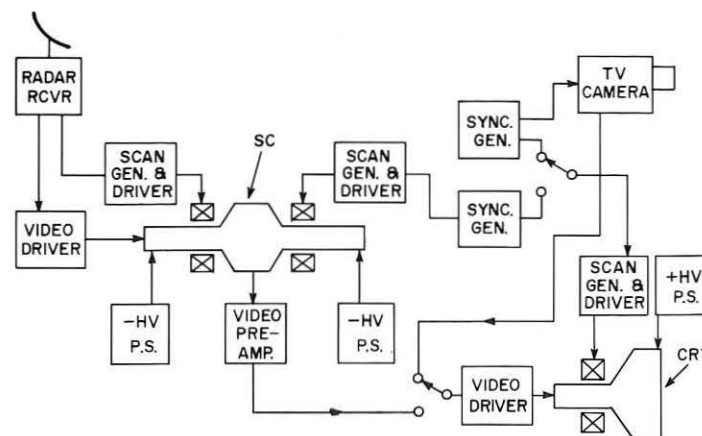

FIGURE 10: SC/CRT approach to multi-sensor display system.

either approach, failure of the ultimate display device makes the over-all system inoperative although failure is less likely to occur in the CRT. For the SC/CRT system, however, failure of the storage device does not affect those sensors which generate signals that are fed directly to the CRT. The significance of these observations can be judged only by the weapons systems analyst.

#### Pattern Geometry

Both the reading and the writing rasters of the C22001 exhibit some pin-cushion distortion because the storage target of this device is a plane surface. However, because the deflection angles are equal on both sides of the SC target, distortion introduced by the writing gun is cancelled by that of the reading gun. Freedom from geometric distortion of the radar pattern in the SC/CRT approach requires control of the linearity of the three deflection systems, rather than the one system of the DST approach.

#### Luminance

The saturated luminance in the DST approach is the same as that shown earlier for TV display service, i.e., 1450 footlamberts, because DST luminance is not a function of the area of the displayed picture, but rather of the area covered by the flood beam. However, the practical operating luminance of the DST system will probably be much lower. As in the case of the display of TV signals, other considerations probably will reduce the luminance of the DST well below the saturated level.

Luminance of the SC/CRT approach is somewhat less than the 1030 footlamberts given previously because the assumed PPI-sector pattern requires a readout display raster on the CRT that is tangent to the assumed useful display diameter of six inches. Under this condition, with an anode voltage of 15 kilovolts and a beam (phosphor screen) current of 500 microamperes, CRT luminance is 480 footlamberts.

#### Resolution

Comparison of the cascaded resolu-

WEIGHT	
TUBE AND SHIELD -	2.95
DEFLECTING YOKES (2) -	1.03
	<b>3.98 LB.</b>

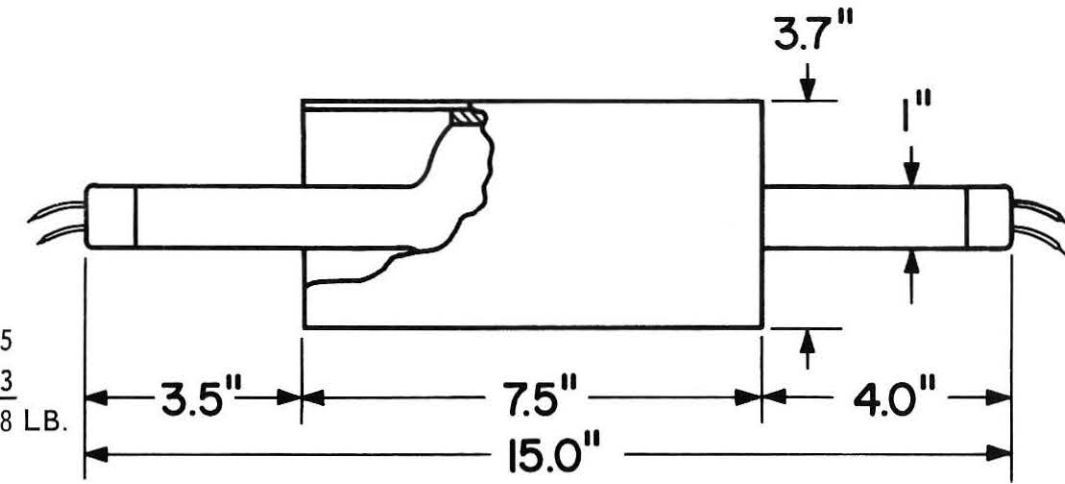

FIGURE 11: Typical size and weight for Graphicon Type C22001.

ESTIMATED WEIGHT	
TUBE AND SHIELD -	1.30
DEFLECTING YOKES (2) -	0.28
FOCUSING COIL (1) -	0.17
	<b>1.75 LB.</b>

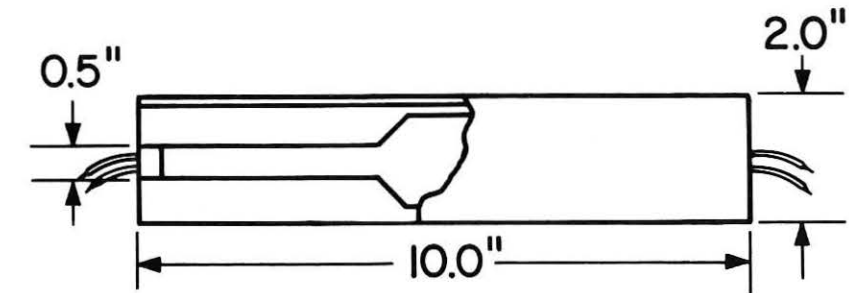

FIGURE 12: Typical size and weight for Graphicon Type C22007.

tion characteristics of the SC tube, the video amplifier between the SC and the CRT, the CRT, and the television raster process with the resolution characteristics of the DST requires the introduction of a resolution-defining concept more amenable to the analysis than the "line-width" definition introduced previously. Such a concept is the frequency-response function, used herein to describe the resolution characteristics of the several devices. This term, sometimes referred to as the spatial-frequency characteristic or modulation-transfer function, is discussed in detail in a series of papers by Dr. O. H. Schade. (See Reference 1.)

Although convenience dictates a different technique, the frequency-response function can, in principle, be measured for a display device in the following manner:

1. The beam scans the phosphor screen repetitively to produce a single straight trace. The scanning waveform is a linear sawtooth.
2. The electron-beam intensity is modulated by a sine wave having a frequency which is a multiple of the line-scan frequency. Thus, the signal produces a series of alternately bright and dim spots of light.
3. A photometer with a narrow slit oriented orthogonally in the direction of scan is used to inspect the pattern of light spots. The width of the slit must equal a fractional part

of the expected electron-beam width.

4. As the photometer is moved with uniform speed in the direction of the line scan, the resulting output current varies sinusoidally.
5. By use of a modulating frequency which allows only a few spots to be presented per display diameter, the peak amplitude of the sine-wave photocurrent signal is noted and assigned the reference value 1.0.
6. Steps 1 through 5 are repeated for increasing values of modulating frequency until the photocurrent amplitude drops to a small fraction of the reference value.
7. A plot of this data gives the frequency-response function in terms of relative response versus spatial frequency in cycles per unit length.

Analogous techniques may be used to obtain the frequency-response function of such electrical-output devices as scan-conversion storage tubes.

In the analysis of a system of cascaded components, individual frequency-response functions are multiplied, frequency by frequency, to obtain the over-all function, as is done in the analysis of cascaded amplifiers. All frequency-response functions must be based upon the response to a sine-wave input. In many instances, frequency-response functions, particularly those of TV camera tubes, are based upon measurements which use a square-wave input signal. In the instance of electrical-out-

put storage tubes, such as scan-converters, the frequency-response function often is measured by the so-called orthogonal write-in/read-out method. The curves of Fig. 13, based upon theoretical considerations (Reference 2), illustrate the effect of the measurement method upon the shape of the frequency-response function. This function may be used to determine single limiting-resolution and equivalent-bandpass values which are used sometimes to describe the resolution performance of a display device or a system.

The frequency at which the frequency-response drops to a low value, usually 0.02 to 0.04, is the limiting resolution value. The limiting resolution in TV lines per unit length is double the limiting resolution in cycles per unit length. The reciprocal of the limiting resolution in cycles per unit length is approximately equal to the line width, as described earlier in this report.

When the equivalent bandpass of a display system is given, it is equated to that of a hypothetical display system for which the frequency-response function is unity within and zero outside of the stated bandpass. Equivalent bandpass  $N_s$  of a real display system may be determined by point-to-point squaring of the measured sine-wave frequency-response function followed by a determination of the area beneath the squared curve.

The choice between limiting resolu-

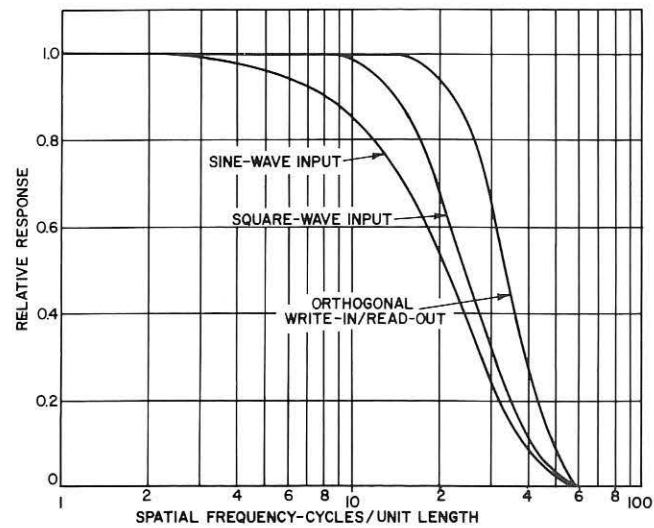

FIGURE 13: Effect of measuring technique on shape of frequency-response function.

tion and equivalent bandpass as an appropriate index of device or system resolution is conditioned by the functional requirements of the display system. If an object in the sensor's field of view must be distinguished from another object in close proximity, the limiting resolution concept may be most useful. However, if a general, faithful reproduction of the real world is important, the equivalent-bandpass concept may be preferred over an analysis based upon either single-valued index.

The frequency-response function of the seven-inch DST hypothesized for this study is shown in Fig. 14. Basic data for the curve were taken on a five-inch RCA DST. In plotting these data, however, the spatial-frequency axis was scaled to conform to the hypothetical seven-inch DST. The equivalent bandpass  $N_e$  for this tube was calculated to be 168 cycles per display diameter. Because the limiting resolution is approximately 500 cycles per display diameter, the following hypothesis is made:

If this DST is used in an offset-sector PPI display in conjunction with a radar system having unlimited receiver frequency response, infinitesimally narrow beam angle, infinitesimally short pulse length, and a 10,000-yard range; then two high-reflectivity targets, each 10 yards square and separated by 10 yards of essentially zero reflectivity, would be barely distinguishable in the display as separate targets. It is assumed that the operator is free to control ambient illumination and to inspect the display as closely as he chooses.

Whether or not this condition is acceptable from a weapons system standpoint involves considerations beyond the scope of this study.

For the SC/CRT approach, the system designer can manipulate several

system parameters for optimum over-all performance; viz., TV raster standards, amplifier bandpass, and amplifier response-shaping functions such as aperture correction. The values chosen for this study are believed to be typical. Separate consideration must be given to the resolution performance in the direction of the raster line structure and in the direction orthogonal to this structure.

Resolution in the direction along the raster lines is a function of the resolution of both scan-converter storage tube and display CRT as well as of the characteristics of the intervening amplifier channel. Fig. 15 shows frequency-response functions for these system elements. The CRT curve conforms with the line-width data discussed previously.

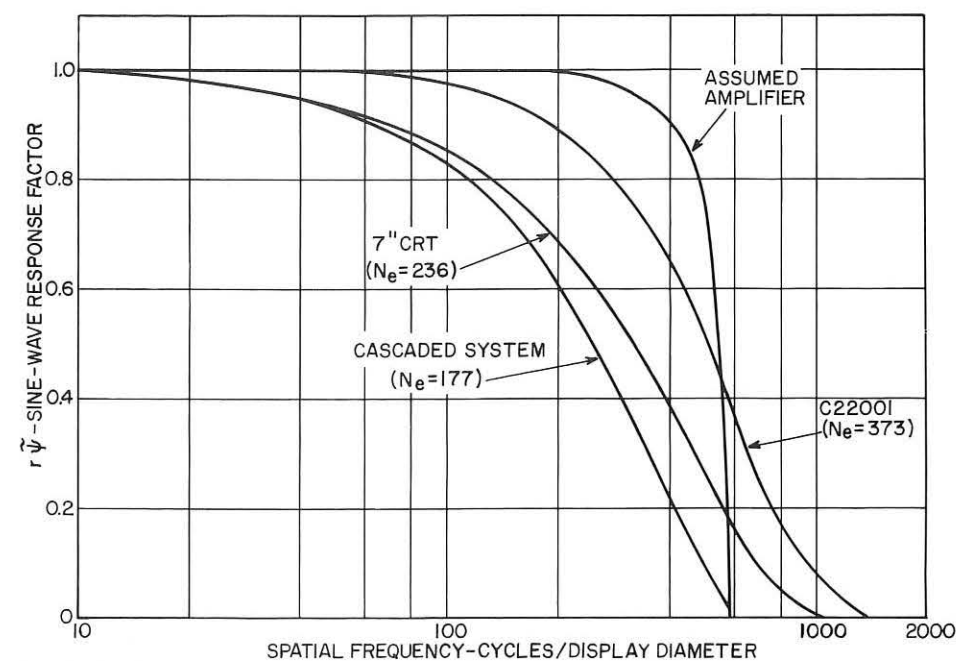

FIGURE 15: Frequency-response functions of elements of SC/CRT system, and of over-all system, in direction of raster lines.

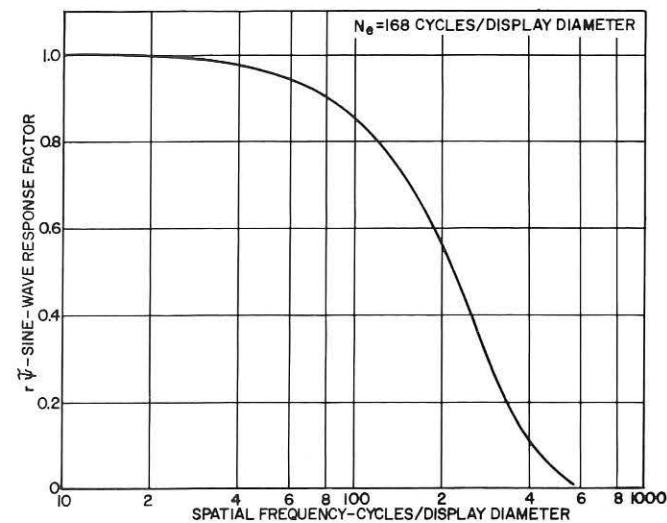

FIGURE 14: Frequency-response function for 7-inch DST.

The SC-curve data were measured by the orthogonal write-in/read-out technique and were transformed to the sine-wave-frequency-response-function form necessary to this study in accordance with the curves of Fig. 13. The assumed amplifier characteristic is for a system which includes a gradual-cutoff, bandwidth-limiting filter. (See Reference 1, Part 3 Fig. 82.) The temporal-frequency cutoff was chosen to give a spatial-frequency cutoff of approximately 600 cycles per display diameter. This cutoff was calculated to be about 17 MHz for a 30-frame per second, 2:1 interlace, 1:1 aspect ratio, 945-raster-line TV format with normal blanking percentages (90 percent field, 83 percent line). The frequency-response functions for these three elements were cascaded to give

the over-all response function shown in Fig. 15. Note that the spatial-frequency-cutoff (limiting resolution) value is approximately the same as for the DST. The equivalent bandpass  $N_e$ , however, is somewhat higher; namely, 177 cycles per display diameter.

Resolution in the direction orthogonal to the raster structure is a function of the raster line number and of the frequency-response functions of both the SC and the CRT. Certain restrictions are placed on the latter to ensure that the final picture exhibits continuity and thus appears to the observer to have no more than a minimal superimposed line structure. Although accounted for in the analysis, the details of these restrictions are not discussed here, because they do not present any systems problems more complicated than underscanning the SC tube's storage target in the direction orthogonal to the raster structure. This mode is necessary to modify the SC tube's frequency-response function in that direction. The applicable frequency-response functions and their cascaded product are shown in Fig. 16. The spatial-frequency-cutoff value is comparable to those shown previously although the equivalent bandpass, 157 cycles per display diameter, is slightly lower.

In the preceding discussion it was assumed that display resolution in the direction along the raster lines should be approximately equal to resolution in the perpendicular direction. For many types of displays, such as normal TV and centered-PPI radar, this condition is de-

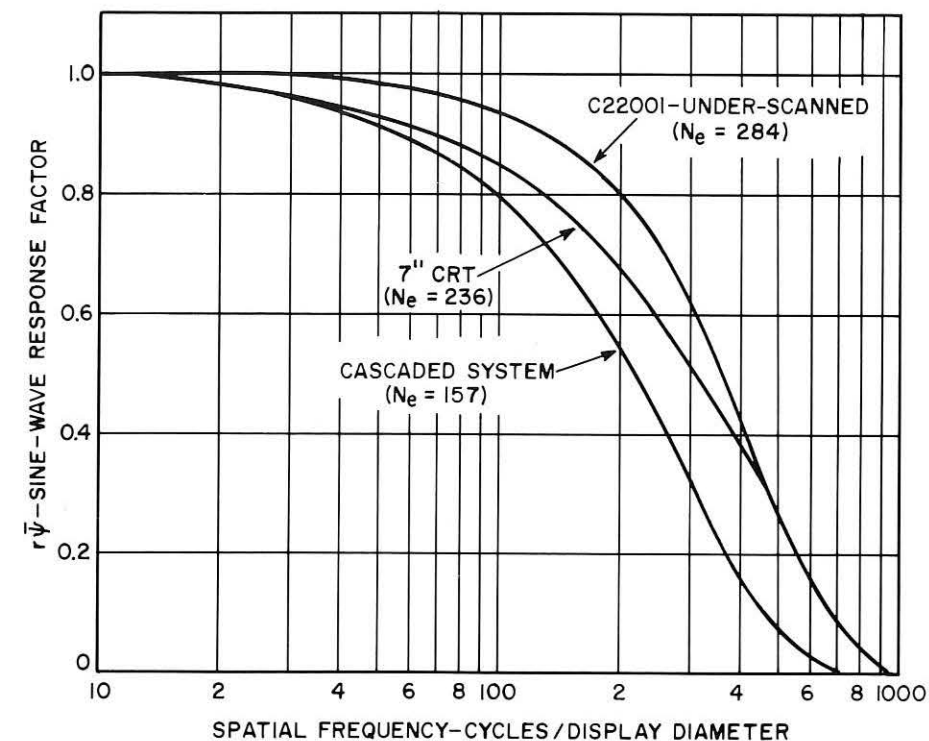

FIGURE 16: Frequency-response functions of elements of SC/CRT system, and of over-all system, in direction perpendicular to raster lines.

sirable. However, in sector-PPI and B-scan radar-display systems, it may be undesirable, because a radar sensor typically provides higher spatial-information content in the range direction than in the azimuth direction. Consequently, the systems designer may consider orienting the raster-line direction on both SC and display CRT so that it corresponds to the direction of aircraft motion. In conjunction with this orientation, system resolution can be increased in the raster-line direction, at the expense of amplifier signal-to-noise ratio, by an increase in amplifier aperture correction. The merits of this technique depend ultimately upon the practical ability of the observer's eye to accept additional detailed information.

#### Uniformity

For the DST approach, the uniformity described earlier in connection with TV displays is also valid for radar displays. For the SC/CRT approach, the non-uniformities of SC and CRT devices are cascaded. A typical non-uniformity characteristic for the C22001 Graphcon is shown in Fig. 17. This illustration represents the output signal corresponding to an input-signal sequence written uniformly across a diameter of the storage target. The level of input-signal drive was such that the output-signal level at the center of the storage target was about 75 per cent of the saturated-signal level. The magnitude of non-uniformity is approximately the same as that of the DST. Unlike

DST non-uniformity, however, it is symmetrical and, therefore, amenable to electrical correction. Such electrical cor-

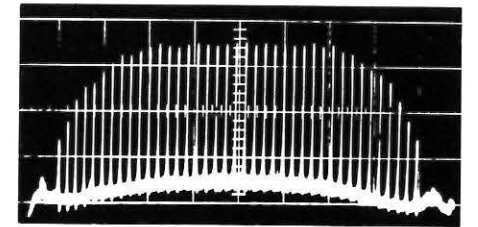

FIGURE 17: Output-signal uniformity of C22001.

rection can consist of two parts:

1. Background shading may be compensated for by additive mixing of line and frame-rate parabolic waveforms with the signal from the SC tube.
2. Signal shading may be compensated for by modulation of the gain of the preamplifier system with similar parabolic waveforms. The only performance penalty anticipated is a decrease in amplifier channel signal-to-noise ratio as a function of distance from the display center. Basic signal-to-noise ratio of the SC/amplifier combination is quite high, as indicated in a later section.

The uniformity performance of the cascaded SC/CRT combination is essentially equal to that of the CRT alone, if the preceding compensation is applied.

#### Persistence (Storage) Characteristics

The choice of persistence (signal-decay rate) for most favorable performance of the display indicator in the sector PPI-radar mode is subject to the operator's preference. However, for ground mapping in a high-speed aircraft, there should be little carryover of the displayed signal from azimuth scan to azimuth scan. If such carryover occurs, the result is a smeared presentation. For this reason, the assumption is that image persistence of displayed signals should decay to about 10 per cent in one azimuth scan cycle, (in this case, two seconds).

With regard to persistence, there is little to choose between the DST and the SC/CRT approaches. In both cases, decay time may be controlled over fairly wide ranges. In the DST approach, decay rate is controlled by adjustment of the erase-pulse duty factor. With the SC, the reading-beam current and/or the storage-target voltage are adjusted. The shapes of both decay characteristics are similar over normal ranges of operation. In this respect, Fig. 7 (DST) may be compared with Fig. 18 (SC). In both cases, decay rate is a function of input signal level, i.e., decay time increases with level of input signal. The curves of Fig. 18 show how SC decay rate and characteristic shapes change with con-

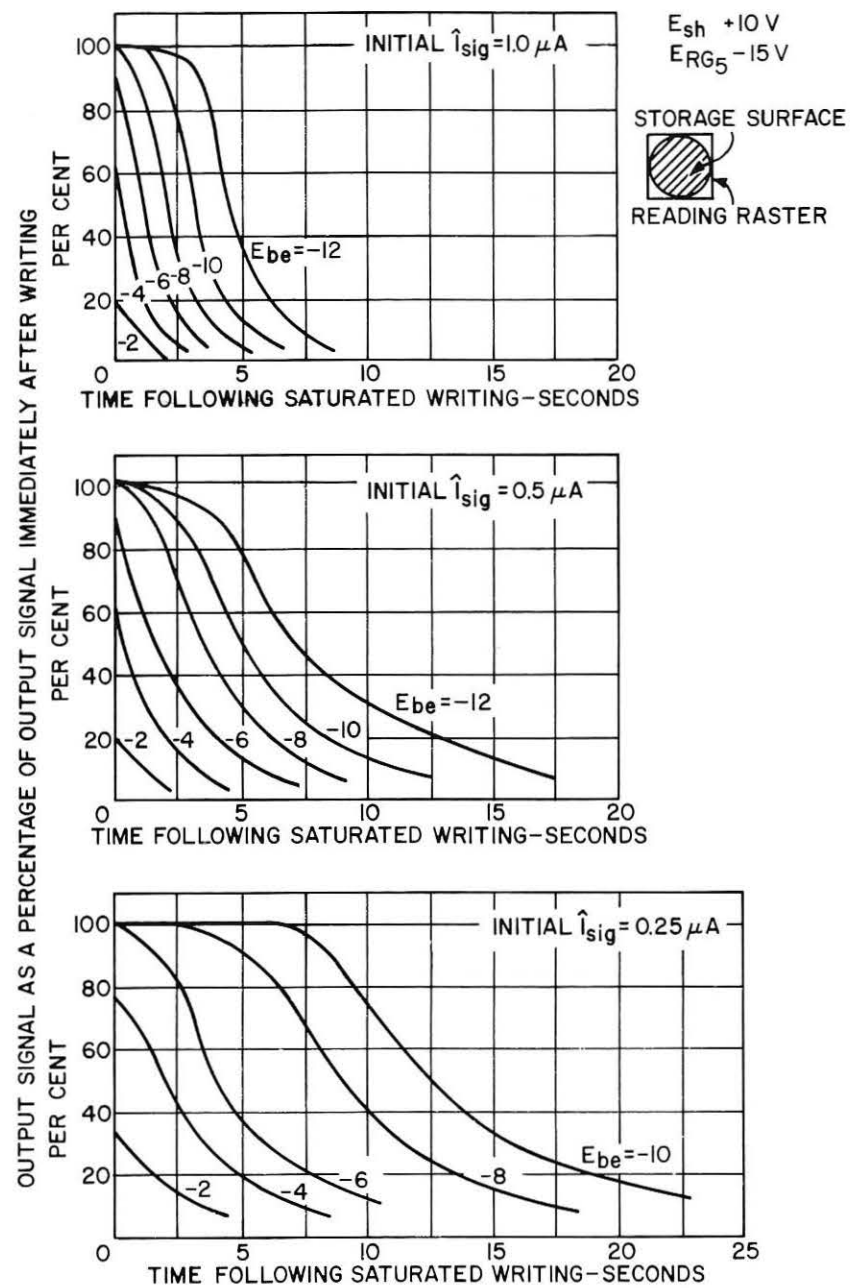

FIGURE 18: "Persistence" characteristics of C22001

control parameters. Normally, backplate voltages more negative than about -7 volts are not used because they result in the saturation (amplitude compression) of higher level input signals, even though they increase the decay time.

#### Signal-to-Noise Ratio

The characteristics of a storage device can influence the signal-to-noise ratio of a radar-display system in two opposing ways. First, noise introduced within the display system may tend to obscure low-amplitude signals, such as those from ground targets of low radar reflectivity. Second, the integrating properties of storage devices employed in radar-dis-

play systems may be used to improve the detection of radar signals obscured by radar-receiver noise. Noise introduced by display-system components is considered first.

As noted in the section on DST uniformity, the threshold for display of low-level signals is not constant as a function of position on the useful display area. (See Fig. 5.) Therefore, low-level signals displayed on a DST may be either superimposed on, or obscured by, display-luminance variations that may be termed coherent noise. These variations usually have a spatial frequency of only a few cycles per display

diameter. Sometimes, moire effects, resulting from the presence of two or more mesh screens in the path of the writing and flood beams, introduce coherent noise at a spatial frequency greater than 100 cycles per display diameter. The level of coherent noise of this type is such that a reasonable estimate for DST signal-to-peak-noise ratio is 10.

Insignificant coherent noise signals in Graphecon-type, scan-converter storage tubes can be cancelled readily. (Refer to the previous discussion of SC uniformity.) However, noncoherent noise is introduced into the SC output signal, primarily in the first stage of the output preamplifier. Although coherent and noncoherent noises in a display do not create the same subjective impression, it may be of interest to indicate, for comparison, the signal-to-noise ratio of the SC/CRT system. For this purpose, calculation of noise-signal amplitude involves preamplifier equivalent-input resistance, effective output capacitance of the SC, and amplifier frequency-response function, including the effect of aperture correction, if employed. The curves of Fig. 18 show that the desired persistence characteristic, i.e., the decay in signal level from 100 per cent to 10 per cent in two seconds, is obtained readily with a backplate voltage of about -6 volts and an initial peak-signal current of 1.0 microrampere. Use of this current value in Schade's Equation 78 (Reference 1, Part 3), with suitable values for the other parameters, produces a signal-noise ratio for a theoretical flat channel expressed as:

$$[R] = \frac{2.13 \times I \times 10^9}{C (R_{eq})^{1/2} (\Delta f)^{3/2}} = \frac{(2.13) (10^{-6}) (10^9)}{(46 \times 10^{-12}) (136)^{1/2} (17 \times 10^6)^{3/2}} = 57$$

This value now is modified by the factor identified by Schade as  $\sqrt{m}$  (Table XVIII, Reference 1) to allow for the shape of the amplifier frequency-response function. For this purpose, it is assumed that the shape, as shown in Fig. 15, includes effects of peaking but has no aperture correction. The modified value is then given by:

$$S/N = \frac{[R]}{\sqrt{m}} = \frac{57}{.76} = 75$$

Because this value represents peak signal-to-RMS noise ratio, it can be divided by six to obtain an approximate peak signal-to-peak-noise ratio of 12.5 for the SC/CRT system.

The problem of weak-signal detection in air-to-air radar modes of operation must now be considered. In this situation, experience suggests that the gain of input amplifier channels is best set so that the DST or the SC is operated in the lower mid-range of the over-all transfer characteristic. Signals obscured by radar-receiver noise are then detected

by the integration properties of the storage device. Random noise pulses charge the storage surface to a level lower than that of the radar-return signals, which are coherent over several range-scan periods because of finite antenna beam width. Thus, radar-return signals appear at a higher output level than does the integrated noise pattern. Detection is improved not only because of this condition but also, perhaps equally, because radar signals persist longer. No attempt has been made to evaluate quantitatively the relative merits of the DST and the SC/CRT approaches in this instance. However, rough operational simulations of the two approaches have been set up in the laboratory, with generally similar results.

#### Transfer Characteristic

The over-all transfer characteristic of the DST was explained in the section which discussed the TV display problem. (See Fig. 6.) The same general characteristic is obtained in radar modes, except that the curve is compressed in the direction of the input-drive axis.

A measured transfer characteristic for the C22001 Graphecon is shown in Fig. 19. The transfer characteristic of the over-all system can be obtained by cascading this characteristic with that of the CRT display device (Fig. 6) and the intervening amplifier. The amplifier may have gamma correction at the option of the system designer.

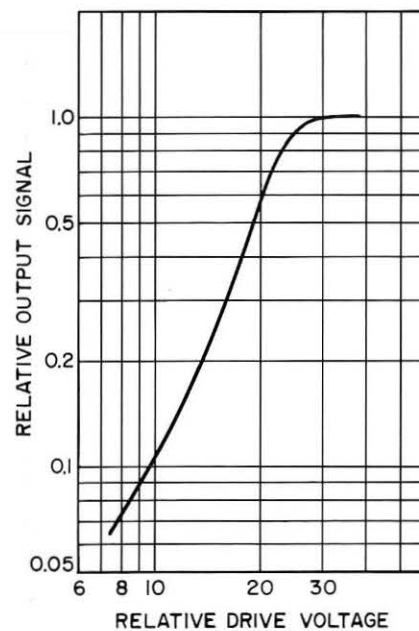

FIGURE 19: Transfer characteristic of C22001.

#### Optimization of Components

A DST designed for use with TV signals is quite sensitive to changes in operating voltages, such as writing-gun bias, when operated in a radar mode. To a first approximation, a tube designed to write a complete picture in 1/30 second at a given level of writing-beam current requires only 1/30 of this

beam current when operated in a radar mode having an azimuth-frame time of one second. Thus, if the video-drive voltage in the TV mode is in the order of 30 to 40 volts, video drive in the radar mode must be decreased to a level where writing-gun power-supply hum voltages, bias shifts, and stray control-grid-circuit leakages begin to influence the quality of the display. Some expedients may be devised to alleviate this problem, e.g., the use of cathode degeneration in the radar mode or the use of a "tetrode" writing gun in which adjustment of the screen-grid voltage changes the effective  $g_m$  of the gun.

The need for fast DST erasing speed in the TV mode of operation introduces still another problem when the tube is used in the radar mode. Regardless of the method used to minimize erasing time, i.e., high floodbeam current density, thick storage insulator, or steepened storage-mesh transfer characteristic, each method tends to increase the rate at which residual gas ions counteract the dynamic erasing process. Because gas ions tend to concentrate at the center of the display, another factor is introduced which can lead to display non-uniformity. This latter display effect becomes more pronounced as the erase rate is decreased to prolong viewing time.

These difficulties show that a DST (or any tube, including the SC storage tube) which is designed to encompass a wide range of operating conditions is not likely to give optimum service over the total range. With the SC/CRT approach, the individual components can be tailored for operation over more restricted ranges: the CRT optimized to give the best possible TV display; the SC optimized to give the best service for processing radar-type signals.

#### Ease of Setup

Setup considerations for the DST were discussed in the comparison of TV display devices. The same considerations apply to the radar mode except for the increased sensitivity of the device mentioned previously.

Setup of the Graphecon-type SC tube is generally easier, not only because the transfer characteristic can be tailored for a narrower range of operation, but also because there is no requirement for the electron beams to be collimated.

#### Summary

The foregoing analysis suggests that display of radar signals can be handled at least as effectively by the SC/CRT approach as by the DST approach. In some respects, e.g., uniformity, resolution, and ease of setup, the SC/CRT approach can be made to have an advantage. In terms of the number of system components and possibly in power consumption and display luminance, the

DST approach may be more attractive.

#### General Summary Multi-Sensor Displays — Two Approaches

In the preceding analyses, an attempt was made to provide the systems designer with a comparison of the merits of two suggested solutions of the multi-sensor display problem. The assignment of significance to the several individual factors considered is not within the experience of tube designers and fabricators, and has been left to the avionics-systems expert. However, the following observations may be relevant:

1. The SC/CRT approach appears to offer:
  - a) Superior display quality in short-persistence modes of operation, e.g., TV modes,
  - b) At least an equivalent display quality in longer-persistence modes of operation, e.g., radar modes,
  - c) Considerable flexibility for future system modifications and additions.
2. The DST approach appears to offer:
  - a) Higher luminance output in some modes of operation,
  - b) Fewer system components,
  - c) System space and weight advantages. (Note: This advantage is valid only in a multi-sensor system having a single final display of relatively small size. For multiple final displays or for larger single displays, the advantage shifts toward the SC/CRT approach. The useful display size at which the advantage shifts is not well defined, but it is probably in the range of 6 to 10 inches.)

#### References

1. Dr. Otto H. Schade, Image Gradation, Graininess, and Sharpness, in Television and Motion Picture Systems, *Journal, Society of Motion Picture and Television Engineers*, Part I — February, 1951, Part II — March, 1952; Part III — August, 1953; Part IV — November 1955.
2. Report R-93, Contract DA-36-039-SC-56695, Storage Tube Resolution, Control Systems Laboratory, University of Illinois.
3. H. A. W. Schober, and R. Hilz, Visual Sensitivity for Square-Wave Gratings, *Journal, Optical Society of America*, Vol. 55 No. 9, pp 1086-1091, Sept. 1965.
4. Final Report, Contract N 6 ONR-23605, Wide-Angle, High Definition TV Systems, RCA Laboratories, August 29, 1952.
5. M. W. Baldwin Jr., The Subjective Sharpness of Simulated Television Images, *Bell System Technical Journal*, Vol. 19, pp 563-587, Oct. 1940.
6. H. R. Blackwell, Contrast Threshold of the Human Eye, *Journal, Optical Society of America*, Vol. 36, pp 624-643, Nov. 1946.



# IBM Graphic Display System

by Russell J. Houldin

Development Engineer  
Systems Development Division  
International Business Machines Corporation  
Kingston, New York

## Abstract

Computer displays with graphic capabilities have added a new dimension to data processing by making information more accessible and more easily assimilated. Summaries, graphs and charts can be quickly retrieved and viewed on many screens simultaneously. Several of the more advanced displays are beginning to link the creativity of man and the calculating power of the computer for design applications.

The IBM Graphic Displays are among such versatile systems — extending the data processing power of IBM System/360 to handle graphic and design information in scientific, engineering and management applications.

Computer-programmed line drawings and alphanumeric are stored in a local display buffer and displayed on a 21-inch CRT. Alphanumeric information can be originated or modified off-line from the computer by a keyboard. Application-oriented instructions can be sent to the computer by an overlay-coded Programmed Function Keyboard. A light pen gives the operator detection, tracking and sketching capabilities.

The display systems are available in models for single or multiple console installations. Multiple installations use control units, each attaching up to four display consoles.

## Basic Display Characteristics

The display area of the CRT is 12 inches square. A 10-bit X and Y magnetic deflection system locates the beam at the intersections on a grid of 1024 by 1024 raster units. A P7 phosphor was chosen for long life and medium image fade out. A regeneration rate of 40 cps was chosen to provide a flicker-free image.

Line width is one and one-half raster units. Beam deflection velocity is held constant to achieve uniform intensity over the length of the line. Beam deflection time is proportional to the number of raster units of deflection in the direction (horizontal or vertical) of greatest beam movement. Four data bytes (32 bits) are required to define each graphic X-Y coordinate.

## Buffering

A local buffer relieves the computer of the heavy regeneration workload imposed by a CRT display. In addition, the buffer is used with the character generator and alphanumeric keyboard to assemble and edit messages before they are transferred to main computer storage.

## Vector Generation

Basic graphic capabilities are point plotting, beam positioning and drawing of vertical and horizontal lines of unlimited length and 45° lines of limited length. The vector graphics feature permits a straight line to be drawn between any two X-Y coordinate addresses.

Two graphic modes are available: absolute and incremental. Information in absolute mode is drawn to the coded X-Y coordinates. Incremental mode information is coded as the number of raster units to be moved. A pattern coded in incremental form is preceded by an absolute positioning coordinate. The beam then traces the incremental mode image relative to the absolute positioning coordinate. A frequently-used pattern can be coded once in incremental mode and then displayed in multiple locations by changing the absolute positioning coordinate. Point plotting in either absolute or incremental mode is also possible.

Absolute mode deflections may be of any length while incremental mode deflections are limited to 63 raster units. This limitation makes it possible to code each incremental beam deflection in two data bytes (16 bits) instead of the four (32 bits) required for absolute mode deflections — doubling the number of vectors that can be stored in the local buffer and halving the access time required to bring each vector from the buffer.

## Alphanumeric Keyboard

An alphanumeric keyboard is used to compose and edit messages. A variable number of storage positions can be reserved by the programmer for message composition from the keyboard. When the entire message is composed, displayed on the screen, and visually verified, it is transferred to main storage.

A symbol, called the cursor, is shown on the CRT to identify the position at which the next character from the keyboard will be displayed. The cursor symbol is a dash and is displayed beneath the character position as an aid to the operator. It can be positioned by programming or by using the keyboard.

The cursor can be advanced or back-spaced either in single-space or continuous mode. It can also be "jumped" through an entire character field and intervening graphic into the next character field.

## Character Generation

Characters can be created in two ways:

- Having the computer create them out of individually-addressed points or vectors; and by
- Using the character-generator feature to translate character codes into the sequence of analog signals needed to trace them on the CRT.

The character generator will display a font of 63 characters at higher speeds and with less buffer space than can be executed in graphic mode. Each character is stored in the buffer as a single data byte (8 bits). After it is retrieved from the buffer, the character is decoded and broken down into a sequence of strokes (straight-line beam deflections) by a logic matrix.

These strokes define the end points in a 3-bit X and Y coordinate system. They also drive a special high-speed, magnetic-deflection character yoke which modulates the field generated by the main graphic yoke.

To draw characters, the beam is first positioned at the X-Y coordinate at which the first character is to appear. The first character is then brought from the buffer and drawn by short, high-speed motions of the beam under control of the character yoke. Upon completion of the character, the beam is automatically spaced to the starting point for the next character in the line. If the line is filled, the beam will automatically be positioned at the first character position of the next line.

A "New Line" code can be used to terminate a line without filling it up. A "Null" code reserves a character space in the buffer which is invisible to the display. It is used for deleting letters or words without leaving gaps in the message.

The standard set of characters consists of 63 alphabetical and numerical characters and special symbols. Either of two character sizes can be selected by programming: basic, or large (1-1/2 times basic size). The basic-size characters provide 3,848 character positions on 52 lines of 74 characters each. The large-size characters provide 1,715 character positions on 35 lines of 49 characters each. An unlimited number of special symbols of any size can still be formed by individually-addressed points or vectors.

Keyboard information is entered directly into the display buffer for each key depression and then displayed to the operator via the character generator. For consoles which do not contain the character-generator feature, the keyboard information is returned to the controlling computer. The characters can then be coded in graphic form by computer pro-

TABLE 1: Display console characteristics

Characteristics	2250 I	2250 III
Basic Graphics	Standard	Standard
Absolute Vectors	Optional	Standard
Incremental Vectors	Optional	Standard
Local Buffer Size	4K or 8K	Note 2
Local Buffer Access	4 $\mu$ sec./byte	1.0 $\mu$ sec./byte
Character Generator	Optional	Standard
Alphanumeric Keyboard	Optional	Optional
Function Keyboard	Optional	Optional
Light Pen Detect	Optional	Standard
Graphic Design	Optional	Standard
Number of Control Units	Note 1	4 per 2840 II
Cable Length (maximum)	100 ft.	2,000 ft.

### Notes:

1. Control unit built in.
2. 32K shared between 2250 III's

TABLE 2: Quantity of vectors or characters displayed<sup>1</sup>

Information		2250 I	2250 III(2)	2250 III(4)
Incremental Vectors	16 raster units	2370	2800	2800
	31 " "	2300	2400	2400
	63 " "	1730	1825	1825
Absolute Vectors	16 " "	1340	2125	1400
	31 " "	1340	2070	1400
	63 " "	1340	1825	1400
	127 " "	1200	1250	1250
	511 " "	465	465	465
	1023 " "	250	250	250
Basic Characters <sup>2</sup>		2100	2100	2000
Large Characters <sup>2</sup>		1750	1750	1650

<sup>1</sup>The 2250 III's are separated from their control units by 100 feet of cable. Performance will vary with cable length. The regeneration rate is 40 cps.

<sup>2</sup>The message used was Lincoln's Gettysburg Address.

gramming and returned to the console buffer for display.

## Programmed Function Keyboard

The Programmed Function Keyboard is a portable 32-button unit with an indicator light for each button. The indicators are set by computer command and can be used to instruct the operator which functions can be performed. The function of each key and indicator is program-defined by interchangeable coded overlays. Key and light functions are identified by nomenclature on the overlays.

Depression of a button causes the com-

puter to be interrupted for transmission of the button's code. An 8-bit binary code punched into the overlay and sensed by switches is transmitted to the computer at the same time. The computer then acts on the displayed image as directed by a subroutine associated with the overlay code and key selected. For example, the subroutine might direct the computer to enlarge, reduce or delete the image displayed.

## Light Pen Detection

The light pen — a hand-held, pen-like device — permits the operator to identify a character, point or line to the com-

puter for subsequent action. When the pen is pointed at a portion of the image and enabled with a switch, the address at which the information is stored in the local buffer is transmitted to the computer. The computer will then modify the image or take other action specified by the program.

## Graphic Design

Display systems with graphic design features use light pen buffer orders to accomplish the following additional functions:

- Movement of incremental mode images with a tracking symbol;

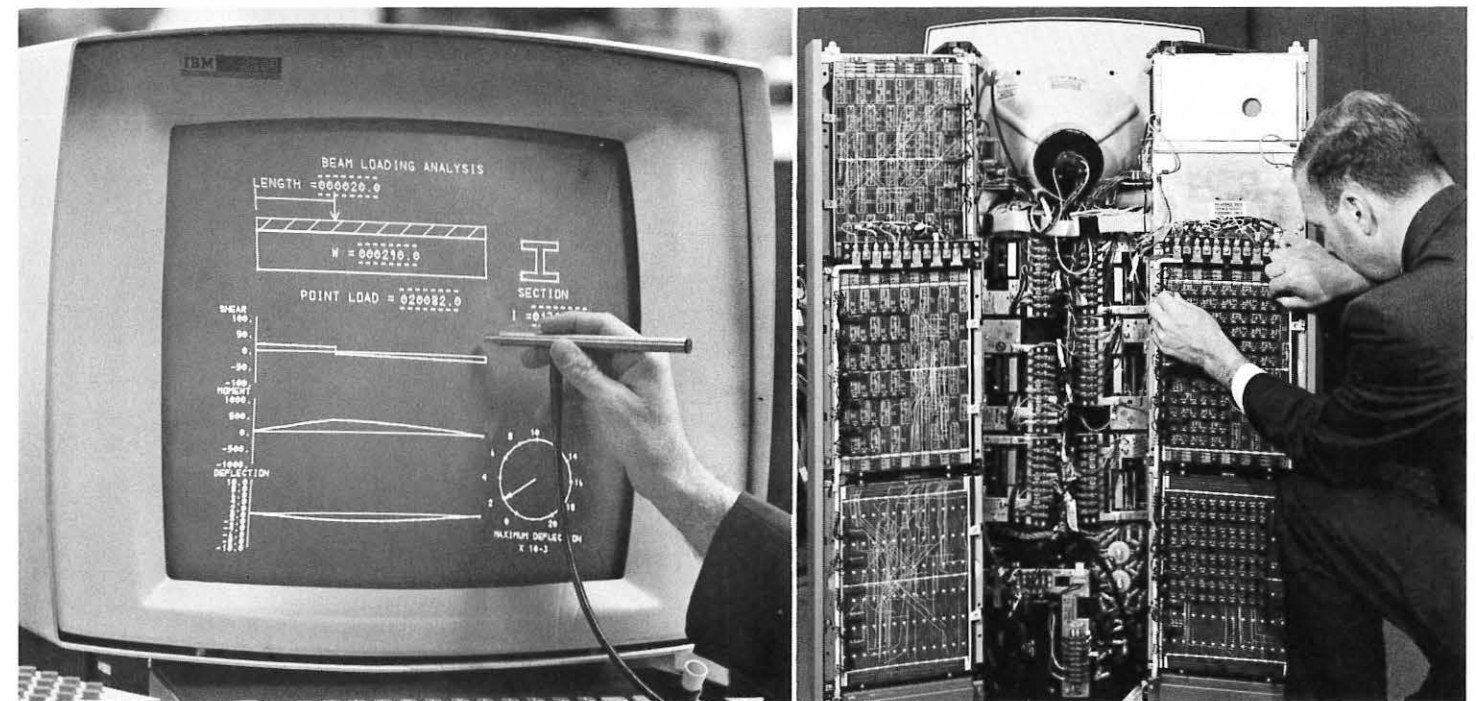

FIGURE 1: A possible application is to use the light pen to vary the load, point of load, and dimensions of a beam. The computer then determines new shear, moment, and deflection values, and plots them in the display.

FIGURE 2: An engineer demonstrates the display system's ease of accessibility. Power supplies are located under the CRT yoke. The panels on either side of the power supplies contain the logic and analog deflector circuits which swing shut after servicing.

- Sketching — by positioning a tracking symbol and entering the screen coordinates into the buffer;
- Branching to other buffer locations; and
- Multiple display of incremental-mode images stored once in the buffer.

#### Console Organization

The 2250 Model III display console and 2840 Model II multiplex control unit are used together in multiple-console installations. A simplex control unit is built into the 2250 Model I console. The Model III will be described.

Absolute vector data bytes are accumulated in X and Y assembly registers at the display console. When the previous beam motion is complete, the new coordinate is immediately transferred from the assembly registers into the deflection registers, and another graphic coordinate is requested from the buffer. Therefore, the time required to bring an X-Y coordinate from the buffer largely can be ignored since it is overlapped with beam deflection for the previous vector. This approximately doubles the number of vectors that can be displayed without flicker.

Incremental vector data bytes are accumulated in separate registers and added to the contents of the X-Y deflection registers. The sums are accumulated in the assembly registers. The remainder of the operation is the same as for absolute vectors. Obtaining the incremental vectors and computing the new absolute vector coordinates are overlapped with deflection for the previous vector.

The high-speed character yoke modulates the beam around the position held in the X-Y deflection registers. A blanked absolute vector is normally used to position the beam for the first character. The characters are broken down into line segments (strokes) at the control unit, and are transmitted to the display console one stroke at a time. Each stroke contains three bits for X deflection, three bits for Y deflection, a blank/unblank bit and an end bit.

A "1" in the end-bit position accompanying the last stroke of the character starts an add sequence in order to compute the position of the next character in the line. When the add is complete, the new X position is transferred into the X deflection register. If an overflow out of the X adder takes place — indicating that the line is full — the X-deflection register is set to zero and a Y add is initiated to position the beam at the first character-position of the next line.

The line can be terminated prior to overflow by placing a New Line code in the buffer. The control unit translates this into a unique stroke code which — when decoded by the control unit — forces an X-adder overflow. Blank and



FIGURE 3: The 2250 Model I main control logic is in servicing position. The logic gates swing up and fan out for ease of servicing. A maintenance panel provides trouble-shooting capability off-line from the computer.



FIGURE 4: The IBM display systems are direct-view CRT display systems designed for single- or multiple-console installations. Multiple units can be separated from their control units by up to 2000 ft. of cable. Detection, tracking and sketching can be performed with a light pen.

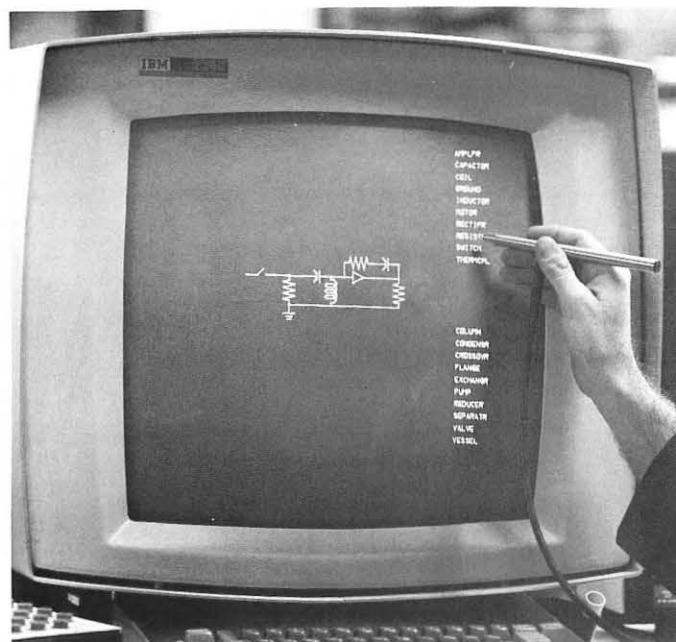

FIGURE 5: A possible application is to construct a circuit with the light pen and programmed function keyboard. Components are selected from the table at the right with the light pen. The circuit location is identified with the pen and computer action is initiated through function keys.

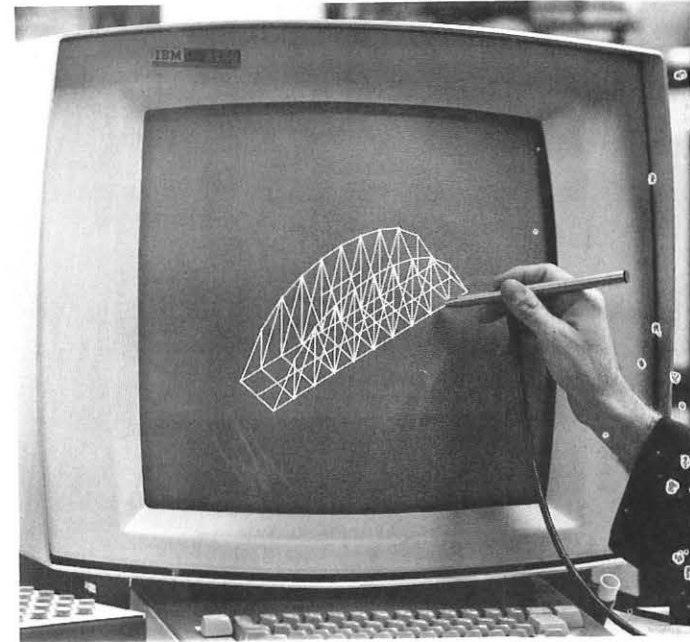

FIGURE 6: The display shows a three-dimensional view of the structural members of a bridge. Function keys are used to call for other views or for expansion or contraction by the computer.

null codes are also sent to the control unit as unique stroke codes. The blank code causes the beam to space to the next character position, while the null code results in no motion of the beam.

A minimum of two and a maximum of nine strokes are used in a character. Using a variable number of strokes per character keeps display time to a minimum. Consequently, display time varies from character to character.

Button and overlay codes are transmitted from the Programmed Function Keyboard directly to the computer via the control unit. The keyboard is interrogated by the control unit once each regeneration cycle; if a button has been depressed, an interrupt to the computer program is generated. The keyboard indicator lights are driven from a register set by computer command.

Alphanumeric keyboard data are entered into the control unit buffer at the address occupied by the cursor. The cursor appears as a solid line under the character which will be replaced by the next keyboard entry. An unique stroke code preceding the cursor strokes causes a dc bias current to be sent into the character yoke. This produces a downward shift of the character matrix and results in the cursor being displayed under the character. One bit in each buffer location is reserved for the cursor. The cursor bit will occupy the location of the character under which it is to be displayed. Since two characters are stored in each buffer location, an odd-even trigger is used to identify the character associated with the cursor.

The control unit interrogates the console for alphanumeric keyboard data once each regeneration cycle. If a key has been depressed, the character stored at the buffer location occupied by the cursor is replaced by the keyboard data entered, the odd-even trigger is complemented and the cursor is moved to the next higher buffer address.

Advance, backspace and jump keys produce cursor motion without altering the message. The end and cancel keys transmit control information to the computer. The end key indicates that the message is complete, while the cancel key requests that the data field be erased.

The graphic-design light pen collects light emitted by the CRT phosphor and pipes it through a fiber bundle to an amplifier located in the console frame. A detection signal is sent to the control unit which then takes action in accordance with the program stored in the buffer. Light-pen tracking and sketching can be performed without computer interaction. Entire range entities coded in incremental mode can be moved on the screen via the tracking symbol. An image entity can be identified to the computer program for action, expansion or contraction for example, by transmitting the buffer address of the image entity to the computer.

#### Control Unit Organization

The control unit contains the System/360 data channel controls, a 32k-byte buffer, a character-stroke generator and multiplex control logic. Any portion of

the buffer can be assigned to any attached console. Each console's location in its display program is maintained in its own buffer address register. The address register contents are modified by a common buffer-address counter which can be incremented or decremented. Image regeneration is started or stopped independently for each console by computer command. An unconditional transfer order at the end of each display program starts the next frame of the image.

The execution time required to display a flicker-free image is 25 milliseconds. Images requiring less than this amount of display time will be held to a 40-cps regeneration rate and therefore to a constant intensity by a special buffer order called the set regeneration timer (SRT). This order must be stored in the buffer as part of each image. Each SRT starts a 25-millisecond timer which is sampled the next time an SRT order is decoded. Program execution is delayed after each SRT until the 25 milliseconds has elapsed.

The consoles share buffer cycles through interleaved accesses to the buffer. Buffer access time is 2.0 microseconds per byte pair. Each order requires one or more buffer accesses, each absolute vector two accesses, each incremental vector one access and each character one access. Each console is polled sequentially for buffer service to assure equal priority. Buffer access for one console and polling for the next service request takes place concurrently. This effectively eliminates polling de-

lays. In periods of heavy regeneration demand, buffer efficiency will approach 100 percent.

Data is transmitted directly to the console one byte (or stroke) at a time. Characters are held in buffer registers and translated into strokes for transmission to the console. The stroke generator is multiplexed between consoles in the same manner as the buffer. A separate clock and polling ring is used in order that the stroke generator can function independently of the buffer and generate strokes concurrently with buffer access for another console.

Graphic data is also held in buffer registers until it can be transmitted to the consoles. Transmission is over the same lines as used for strokes and is controlled by the stroke-generator clock and polling ring. This was done to minimize the number of registers, controls and transmission lines required.

Transmission of data to and from each console is over a coaxial cable which can be up to 2000 feet in length. This allows the consoles to be located in actual work areas rather than be restricted to the computer room. Convenience to the operator is a necessity if the consoles are to be used for everyday design jobs. Because of the expense of a 2000-foot cable, the number of signal lines was held at 20. This was accomplished by designing a computer-type interface with separate order, control and data lines.

Orders are placed on the lines in a five-bit binary code. Enter-basic-character mode and enter-incremental-point plot mode are examples. Control signals are not coded and require one line per function. Examples are data sampling pulses sent to the console and light pen responses returned to the control unit. Nine of the lines are used for data transmission (eight data, one parity) in either direction. Over these lines, character, graphic and function keyboard indicator bytes are sent to the console and keyboard and console-status information is sent to the control unit. The status byte is returned to the control unit in response to a Read Status command once every regeneration cycle. This byte is used to inform the control unit that a keyboard operation has taken place or that a parity error has been detected.

#### Regeneration Timings

The execution time of a display program is determined by order-execution time, data-display time and buffer-access time. The number of consoles operation simultaneously and the length of cable between each console and the control unit will also affect the operation of multiple-console systems.

The execution time required for the control order portion of a program can be approximated by summing the num-

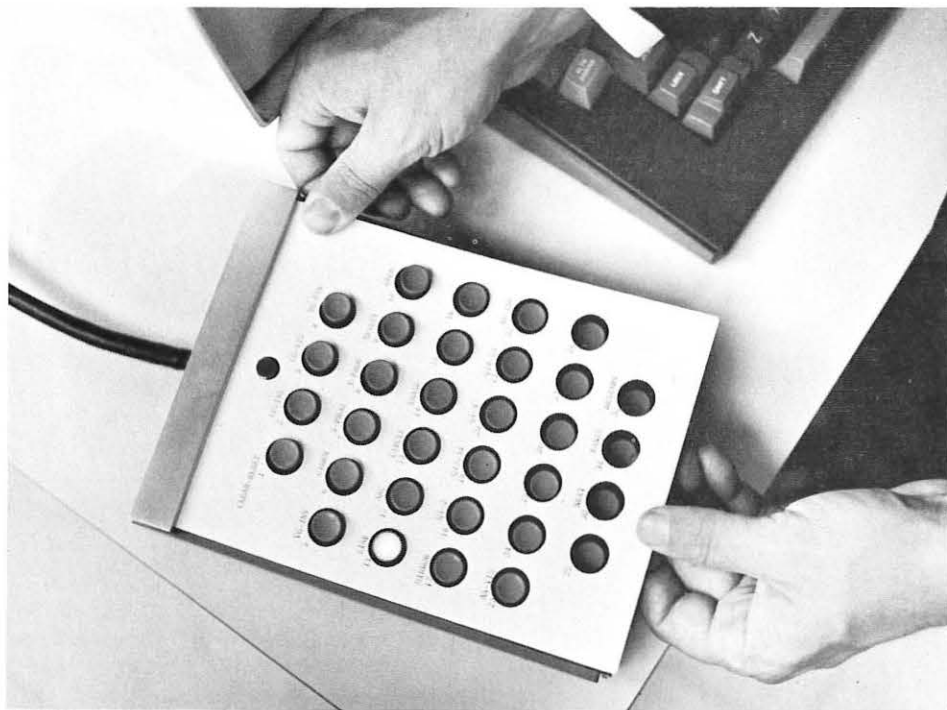

FIGURE 7: Overlays labeled for specific applications can easily be slipped on to the 32-button programmed function keyboard. The computer identifies an overlay from its own code punched into the edge where it is sensed by switches (concealed by the dark frame). As many as 256 different overlays can be used.

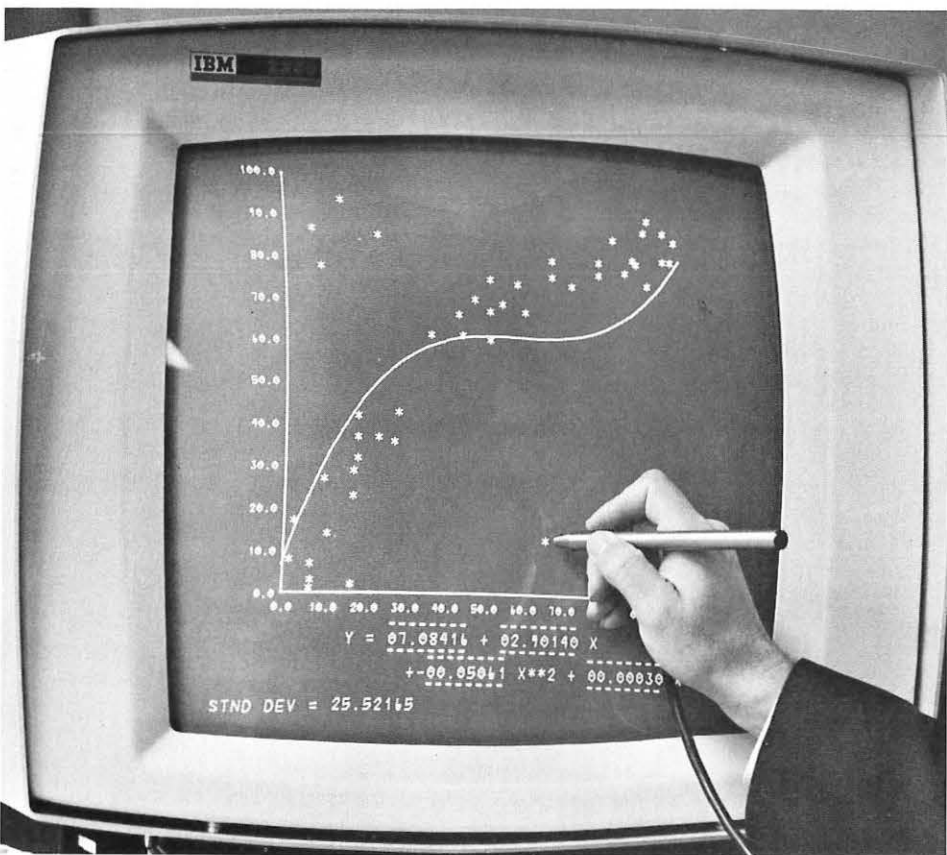

FIGURE 8: Results of an experiment are displayed as points and a curve is fitted to them by the computer. Points deviating so far from expected values as to be questionable can be deleted with the light pen and a new curve computed.

ber of order byte-pairs and multiplying the total by buffer-access time. The difference between this and 25 milliseconds is the time available for actual image display. It is therefore desirable to minimize the number of orders in each display program.

Beam positioning time can be determined from the following formulas:

1.  $N < 16$   
Positioning time = 8 microseconds
2.  $N \geq 16$   
Positioning time =  $8 + 92 \frac{(N - 16)}{1007}$  microseconds

FIGURE 9: The 2250 III display console contains the logic, magnetic deflection system, manual-input devices and power supplies. Adders are used to compute the next character position and to convert incremental-mode vectors into absolute X-Y screen coordinates. Accumulation of the next vector in the assembly registers is overlapped with beam deflection for the previous vector.

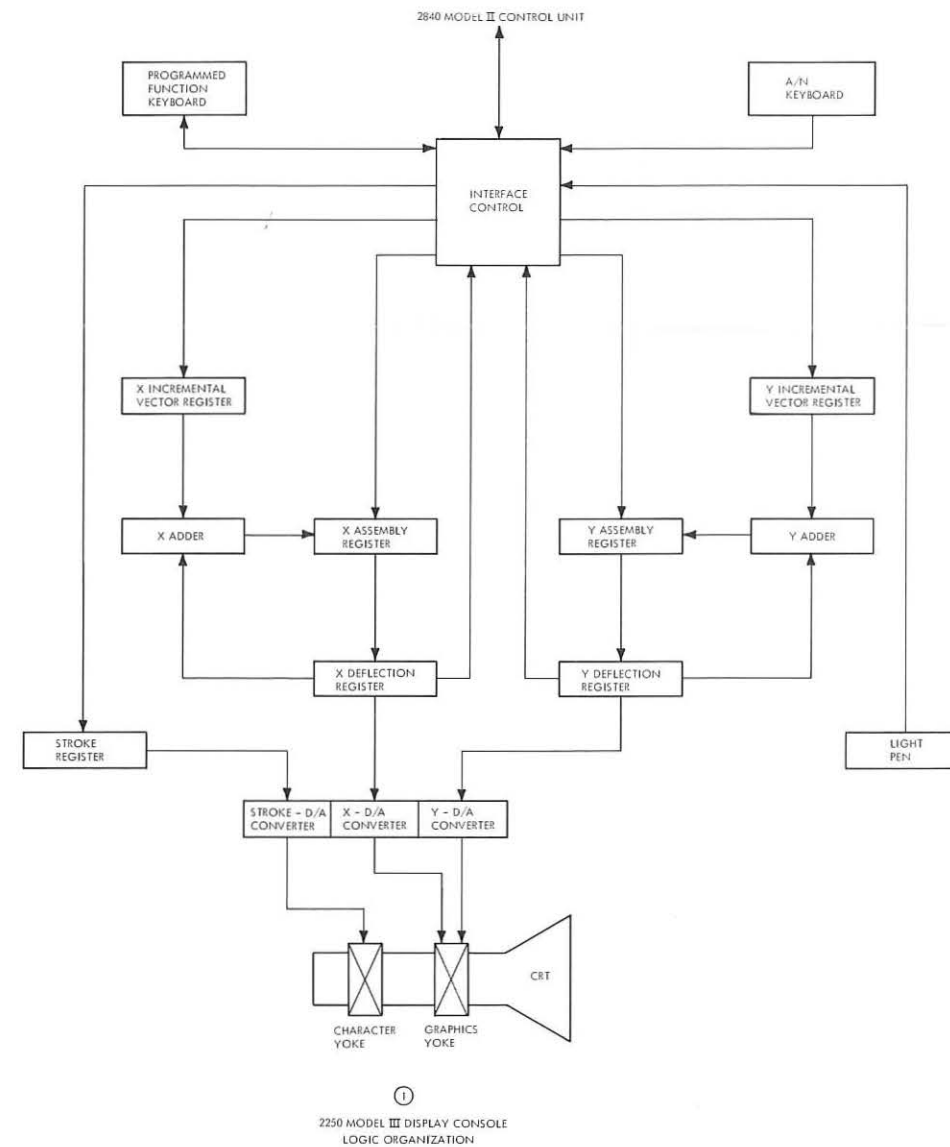

Where:

N equals the number of raster units of the axis (X or Y) having the greater change. For example, when the X-axis change is 100 raster units and the Y-axis change is 1023 raster units (full-screen deflection) then N is equal to 1023.

For points, add one microsecond to beam-positioning time to allow for intensification after beam motion has been completed.

The formulas can be used directly to compute the time to reposition the beam to the start of a new line when in character mode. However, when in graphic mode, the beam-positioning time is not always equivalent to actual elapsed time between adjacent beam deflections and cannot be used in computing execution time for a display program. Obtaining the next graphic mode X-Y coordinate is overlapped with beam motion for the X-Y coordinate being displayed. This time includes polling for buffer-

service requests, buffer access decision and data-low logic delays and cable delays. The sum of these delays often exceeds beam-positioning time for short deflections and results in a wait between adjacent beam motions.

Character-execution time is dependent upon the number of strokes required to draw the character. An average of six strokes is required for each visible character. Spacing, null and new line "characters" are each equivalent to a one-stroke visible character. A text message with a normal complement of spaces will average five strokes per character position. The time required to return to the beginning of a new line can be computed from the beam-positioning formula. For practical purposes, total message-return time is proportional to the number of characters in a message and is independent of the number of lines used. This assumes that all lines start at the left-hand margin and that new-line "characters" terminate each line after the last visible character.

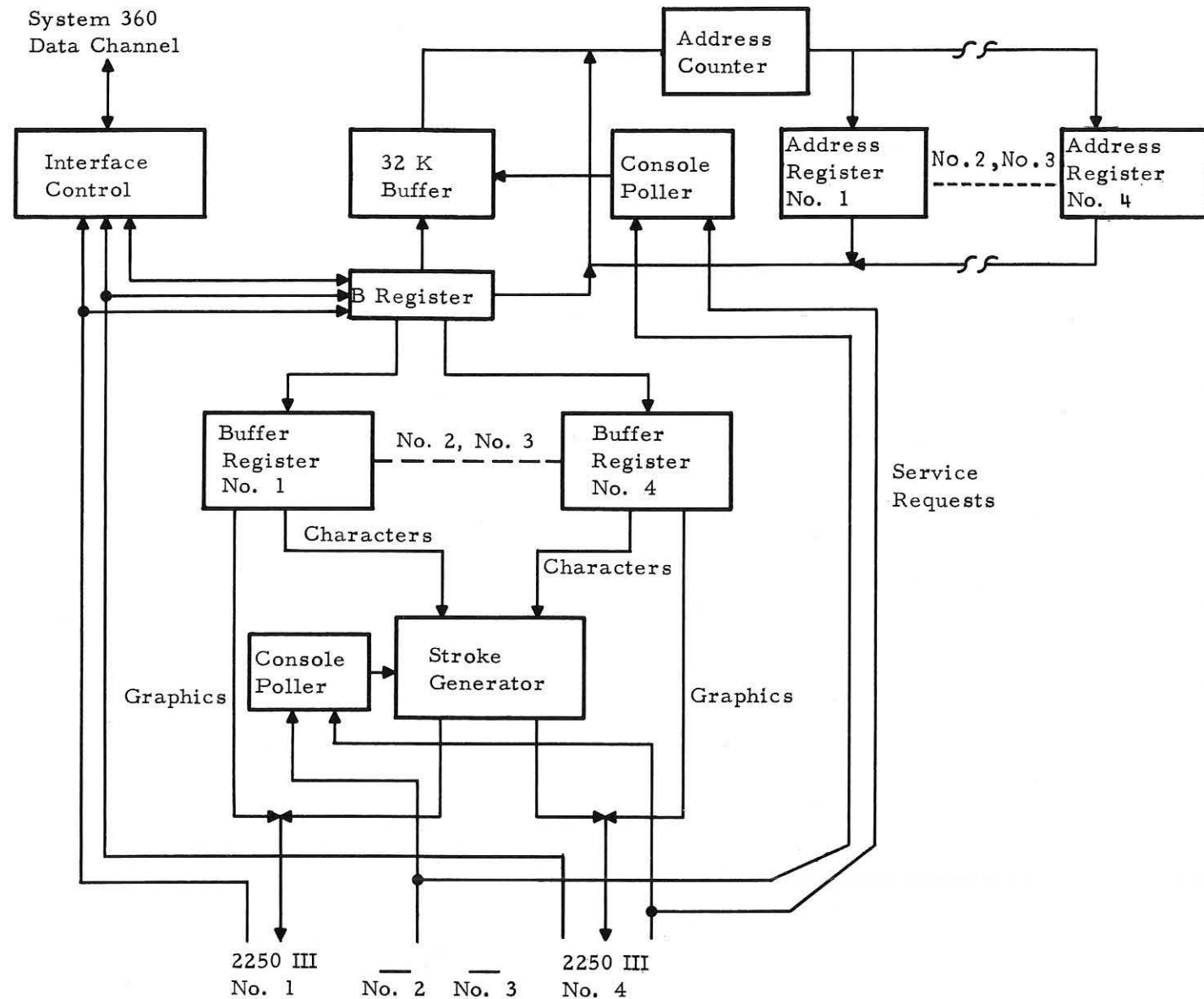

FIGURE 10: The 2840 Model II control interfaces with a System/360 computer data channel. It time-shares a buffer and stroke generator among the 2250 Model III display consoles. Two to four consoles can be attached. The control system is asynchronous in order to avoid delays for consoles not requiring buffer or stroke generator service.

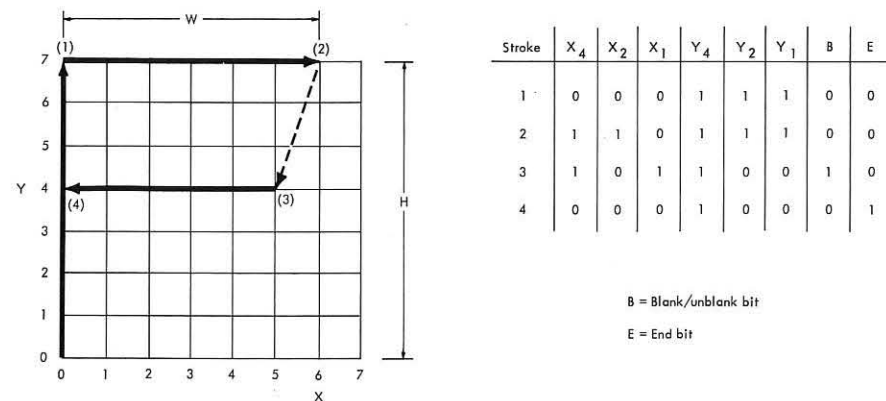

FIGURE 11: The letter "F", superimposed on an X-Y grid, shows a typical character-stroke format. Four strokes are required (their end points have been numbered). The binary information delineating the beam's coordinates are contained in the character-stroke table. The 1 in the "B" column shows that the beam is blanked on stroke 3 while retracing a line.

Characteristics	Character Size	
	Basic	Large
Height	0.16"	0.24"
Width	0.12"	0.18"
Positions/Line	74	49
Lines	52	35

# Recording Media

by Dr. H. R. Luxenberg and R. L. Kuehn

President  
Lux Associates  
Sepulveda, California

Product Manager  
Night Vision Warfare Department  
Electro-Optical Systems Inc.  
Pasadena, California

## Editor's Note

This article is an initial draft of the first portion of Chapter 7, "Recording Media", of the book, *Display Systems Engineering*, by H. R. Luxenberg and R. L. Kuehn, which is to be published in the spring of 1967 by McGraw-Hill; it is preprinted here by permission of the publisher. The remainder of the chapter deals with image resolution, image contrast, and sensitometry, and is fully annotated.

## Introduction

This chapter will discuss certain selected methods by which computer generated information may be prepared in hard copy form for any of a number of reasons. These reasons include immediate viewing, storage for delayed viewing, dissemination for remote viewing, generation of a reproducible master for mass reproduction, or to serve as an intermediate in a film-based group display system.

The hard-copy material may be clear, translucent or opaque, of metal, paper, or plastic. It may or may not require a specially sensitized or treated surface, and may range in size from a 16 mm frame to a 75 x 100 cm (or larger) sheet.

Viewing may be either by direct (front) lighting, rear illumination, or projection by reflection or transmission.

Reproducible masters may be computer prepared for any of the major means of reproduction, e.g. litho (direct or offset) relief, intaglio, stencil, spirit, diazo, dye transfer or electrostatic, in some cases directly, in others with the aid of one of the standard graphic arts procedures.

The copy may be either monochromatic or full color, miniaturized for optimum storage, hand holdable or wall size, and may have a full grey scale

(either by inherent continuous tone properties or by screening) or only a binary grey scale.

The topics to be covered are:

1. Methods of Recording
2. Silver Halide Materials and Processes
3. Non Silver-Halide Materials and Processes
4. Characteristics of Recording Media

## Methods of Recording

Generation of hard copy may be wholly mechanical, either digitally as by driving type hammers, or analog, as by driving an inked pen or an engraving scribe. Generation might be optomechanical, where a beam of light is mechanically deflected over the surface of a photosensitive surface. The deflection may be electro-optical rather than mechanical. The recording might be electrical (as in some facsimile processes), magnetic (as in magnetostatic recording), or thermal (where a heated stylus is used to produce a physical or chemical change in a recording medium).

The primary concern here, however, will be electronic recording methods, in which an electron beam is deflected to trace out the desired information. Two principal means of electronic recording will be covered. These are:

1. Direct beam recording
2. Indirect (optical) recording

In the first the electrons are deposited directly on the recording surface, and the image is "developed" by any of a number of means. In the second method the electron beam activates a phosphor and the resulting light pattern is recorded on a photo-sensitive medium. These two classes of electronic beam recording will be discussed in greater detail in the following sections.

## Direct Beam Recording

Electrons may be deposited on a non-conducting surface by a cathode-ray tube envelope, or, more practically, by

bringing the electrons through the face plate along fine wires embedded in the glass surface. The latter approach is simpler to implement.

The wires may be arranged in a 2-dimensional array so that the entire image may be formed at a single "exposure", or the wires may be arranged in a linear array, with the receiving material moved in synchronism with the electron beam scan. Since provision must be made to transport the receiving material past the face plate for successive recordings, the linear array is more widely used as it permits a continuous rather than an intermittent type transport to be used.

The electron pattern is, of course, not visible but must be "developed". A discussion of development techniques will be deferred to a later section, where the related photoelectrostatic techniques are discussed.

Since direct beam recording is essentially a contact process, the maximum image size is limited by the dimensions of the cathode-ray tube face plate. Most cathode-ray tubes made for direct beam recording have a rectangular face plate with a large aspect ratio, 10:1 or greater, and use either a linear array or at most, a matrix of seven to ten lines of wires so that a complete line of text may be imaged at one time.

In the indirect (optical) recording methods, the visible image on the phosphor face plate of the cathode-ray tube is recorded on a photosensitive medium. Since most of the generally used photosensitive media are sensitive only to the blue and ultraviolet portions of the spectrum, special cathode-ray tubes with ultra-violet output phosphors and/or ultra-violet transmitting quartz face plates are required or preferred in many recording applications.

## Indirect (Optical) Recording

In the indirect (optical) recording methods, the visible image on the phosphor face plate of the cathode-ray tube is recorded on a photosensitive medium. Since most of the generally used photosensitive media are sensitive only to the blue and ultraviolet portions of the spectrum, special cathode-ray tubes with ultra-violet output phosphors and/or ultra-violet transmitting quartz face plates are required or preferred in many recording applications.

As will be discussed in detail below

many sensitized materials are so slow that only "contact" printing is possible. For this purpose special cathode-ray tubes are available with fibre optics face plates. The fibres may be arranged either linearly or in a rectangular matrix, as are the wires in the direct beam recording tubes. The fibres "transfer" the image from the phosphor backing of the face plate to the front surface for maximum resolution.

For optical printing, as opposed to contact printing, conventional face plates are preferred, for maximum image linearity.

#### Silver Halide Materials

The best known of the photosensitive recording materials is the conventional silver halide type. It is by far the most sensitive and versatile of all available materials and it is available in a wide range of spectral characteristics, speeds and resolving powers, as well as having full color capabilities. For these reasons it is the most widely applicable of all photosensitive media. The following sections describe the capabilities of silver halide materials from the standpoint of the display systems engineer. For additional information the reader is referred to the classic texts of Neblette (1) and Mees (2).

Silver halide emulsions consist of a dispersion of silver halide crystals in gelatin. Negative emulsions contain various proportions of silver bromide and silver iodide. Positive emulsions contain various proportions of silver chloride and silver bromide crystals. The crystals range in size from sub-microscopic to around 5 microns. The speed of the emulsion varies directly with the particle size; the image resolution, of course, varies inversely with crystal size.

Silver halide crystals themselves are sensitive only to light in the near ultraviolet, violet and blue regions of the spectrum. The addition of properly selected dyes to the emulsion will extend the spectral sensitivity of the emulsion (to cover the entire visible spectrum and the near infrared) since the light energy absorbed by the dyes is transferred to the silver halide crystals.

The effect of light on a silver halide crystal is the decomposition of portions of the silver halide crystal so that exposed crystals contain atoms of free silver. With certain print-out emulsions the image is directly visible, but very long exposures are required. In order to reduce exposure requirements, the energy required to render the latent image visible is added by a developer.

#### Conventional Development

In conventional development, the exposed silver halide grains are chemically reduced to silver. Actually all of the grains will be reduced to silver with sufficiently long development, but those

exposed crystals which contain silver specks are reduced most rapidly by many orders of magnitude. The development of unexposed crystals produces a background density referred to as fog.

After development, the image is "fixed" by converting the undeveloped silver halides into water soluble compounds and washing these away, to render the image permanent.

#### Two Stage Development

In conventional development, precise control of time, temperature and replenishment rates is required to obtain predictable and repeatable results. An alternate approach is the use of a two stage developer. In this approach the exposed film is first saturated with a solution containing most of the developing components. When the gelatin has been saturated with this solution, the film is transferred to an activator solution, usually an alkali, which enables the absorbed developing agents to operate to completion. Time and temperature control is not critical since the process is allowed to proceed to completion, and replenishment is not required since the development products do not contaminate the more critical first solution. Fixing is done as in the conventional process. The two developing solutions are extremely stable and have very long shelf and operational lives.

#### Activator/Stabilizer Development

This approach is related to the two-stage development except that here the emulsion is saturated with the developing ingredients *before exposure*, usually during manufacture. The activator is generally an alkali, as in the two-stage process. Development by activation is in the order of seconds, and the process is thus nearly dry ("damp-dry") since little moisture is absorbed by the gelatin. To maintain this "damp-dry" advantage, conventional fixing and washing is not customarily used. Instead a stabilizer is used which renders the unexposed silver-halide crystals insensitive to light. The entire activator/stabilizer process can be performed within a few seconds. Films which are to be used with this process must not have the opaque anti-halation backing found on many films since this will not be removed during processing. The images are not archival, but have a useful life measured in months. Archival quality can be obtained by conventional fixing and washing, at a later time.

#### Monobath Development

In this development technique a single solution containing both the developing and fixing agents is used. While the developer is reducing the exposed grains to metallic silver, the fixer is converting the unexposed grains to a water soluble compound and carrying them into solution. This process is generally allowed

to proceed to completion, but time and temperature control may be used to vary the image contrast as desired.

#### Reversal Processing

Films processed by any of the preceding methods have negative images; that is, highlights and shadows are reversed from those in the original scene. To obtain a positive image without the need for a second generation image, reversal processing is used. In reversal processing the image is developed as in conventional processing. The reduced silver is bleached away. The entire image area is then uniformly exposed to render all previously unexposed, and hence undeveloped silver halide grains developable. The film is then developed to completion. While fixing is not wholly necessary, it is generally performed for archival quality, particularly when the second development is not allowed to proceed to completion. In one application of reversal processing to projection displays, only three solutions are used. The first is a developer, the second the silver bleach, and the third is a monobath containing both developer and fix. The film is projected immediately upon removal from the bleach (thus providing the overall second exposure required) in a liquid gate for cooling. The circulating fluid contains the monobath and the image is developed *during* projection within a second or two.

An interesting sidelight on reversal processing is the lower graininess and sharper image of a reversal processed as compared to a negative processed image. This is because an emulsion contains silver halide crystals of a range of sizes. The "fastest" crystals are the large crystals. These are the ones developed during the first development. Thus the grains forming the reversed image are the finer grains in the emulsion.

Two additional methods for obtaining non-reversed silver halide images without the additional steps required in reversal processing are the auto-positive and the photo solubilization techniques. One disadvantage of these methods, at least from the display standpoint, is the reduced speed of the materials.

Autopositive materials depend upon the Herschel effect for their behaviour. The Herschel effect is the name given to the ability of long wave radiation beyond the normal spectral sensitivity of the emulsion to "destroy" a latent image produced by shorter wave radiation. In practice, a blue sensitive material is first thoroughly pre-exposed. The desired image is exposed with yellow light and the film is then processed normally, to produce a direct positive.

A variant autopositive process makes use of the solarization effect, in which a severe over-exposure of radiation to

which the emulsion is sensitive will actually inhibit the developability of the exposed crystals, thus producing, in effect, the equivalent of non-exposure.

The photosolubilization process depends upon the increased solubility of exposed silver halide crystals (over non exposed crystals) in the fixing solution. This effect may be strongly enhanced by the incorporation of certain additives in the emulsion.

Photosolubilization processing involves "fixing" the image first, in total darkness, then developing in bright light. The fix dissolves the silver halide grains at a rate proportional to the amount of exposure. The remaining (originally unexposed) grains are then fully exposed, and when developed, produce a positive image. Post-development fixing is thus not required. Photosolubilization requires a developer and fix, as in conventional processing, but these are used in the reverse order!

A quasi-reversed image may be produced by treating a negative with a combination yellow toner and bleach. The black silver image is thereby replaced with a yellow dye image. This yellow image remains a satisfactory negative for printing on blue sensitive materials. When placed on a matte black background and viewed by reflected light, the yellow negative appears as a black and yellow "positive".

Negatives may be projected as positives by making use of the temperature sensitive characters of fluorescent materials. By projecting the negative with a source rich in infrared radiation on a fluorescent screen uniformly illuminated by ultraviolet light, a positive image is formed. The dark areas of the negative have the luminance of the glowing phosphor, and the clear areas of the phosphor appear dark because of the infrared "quenching".

These last two methods do not affect the speed characteristics of the film used.

#### Diffusion Transfer Processing

This process produces an archival positive image, and a negative image which may be made archival by conventional processing. Diffusion transfer processing is very nearly dry. In this a monobath, either a liquid or a jelly, is applied to a nonlight sensitive material which is then pressed in intimate contact with the unprocessed negative.

The monobath contains a developer and a silver halide solvent. While the exposed grains in the negative are being developed, the unexposed grains are being carried into solution. The receiving material contains a non-visible microscopic dispersion of silver in gelatin. The silver halide solution plates out its silver on the grains in the receiving material. Little lateral diffusion takes place, INFORMATION DISPLAY, SEPTEMBER/OCTOBER, 1966

and because of the plating process, there is very little granularity in the transferred image.

The positive is formed rapidly. More time is required if the negative is also to be preserved to permit all of the unexposed silver halide to be dissolved. Archival preservation of the negative and removal of the anti-halation backing on the negative requires conventional fixing and washing. The positive is archival, and no fog level is present in the image.

#### Color Formation

Silver images are black, due to the opacity of the silver. The silver may be bleached away, either as part of the development process or afterwards, and replaced by transparent dyes, the density of which is proportional to the amount of silver originally present. In films with multiple emulsion layers, each layer may be selectively dyed, by using different couplers in each emulsion. This process forms the basis for color photography. In the Land Polaroid process the color formation proceeds simultaneously with the diffusion transfer processing.

The clear areas of the emulsion may also be tinted to produce a two-tone effect.

It is important to the display engineer to note that color film (or monochromatic film which has been dye-toned) has far less tendency to buckle or shrivel (or even melt!) during projection. This is because dyes are transparent to infrared radiation whereas the finely divided silver grains, act like black bodies and absorb nearly all incident radiation.

#### Relief Images and Dye Transfer

The exposed areas of a silver halide gelatin emulsion can by proper development be selectively hardened, i.e. made less water soluble than the unexposed areas. It is thus possible to bleach away the silver, leaving a completely clear film, and, with warm water, wash away the gelatin in the unhardened areas to produce relief image. The relief image (referred to as a matrix) may be used to print duplicates in any desired color, since it will imbibe dyes in amounts proportional to its thickness. The dyes are transferred to a receiving layer by mechanical contact. This process has not been used to any extent in display systems, but forms the basis for the Technicolor release print process and for certain graphic arts and office copying processes.

#### Non-Silver Halide Materials and Processes

The non-silver halide materials and processes have found their principal applications in the graphic arts, but at least three classes of processes have been adapted to display systems use. These three classes, and their principal

subclasses are:

- I. Diazotype
  - A. Dye Diazos
    1. Dry Process
    2. Moist Process
    3. Negative Process
  - B. Thermal Diazos
  - C. Vesicular Diazos
- II. Photochromics
  - A. Organic
  - B. Inorganic
- III. Photoconductive Electrostatic
  - A. Pigment Development
    1. Direct
    2. Indirect
  - B. Heat Development

The restriction of the following discussion to these three classes is not meant to imply that other available techniques have no place in display systems. Rather, it could be accepted as a challenge to investigate the applicability of these well-developed techniques. The best single source of information on non-silver halide systems is Kosar (3).

#### Dye Diazos

Azo, from the Greek azote (without life, i.e. incapable of supporting life) is the chemical combining form meaning nitrogen. Diazonium compounds popularly referred to as diazos, are organic compounds containing pairs of nitrogen atoms. Diazonium compounds, which are generally pale yellow in color, can react with colorless "couplers" in an alkaline environment to form brilliant azo dyes. The choice of the diazoniumcoupler combination determines the color of the dye.

Diazonium compounds are decomposed under irradiation by ultraviolet light into colorless, chemically-inactive compounds, releasing free nitrogen in the process. The decomposed diazonium is incapable of reacting to form a dye. These basic properties of the diazonium compounds form the basis for the widely used diazotype reproduction processes.

Two such processes, the moist and the dry, are in common use. In the dry process the coating contains one or more couplers, a weak acid to inhibit premature coupling, and various other (generally proprietary) ingredients for moisture control, image stability, etc.

After exposure to ultraviolet light of those areas of the coating which are to become colorless, the coating is treated with aqua-ammonia vapor to neutralize the acid and the azo dye is formed in the unexposed areas.

In the moist process the coating contains neither coupler nor inhibitor, and development is by application of the coupler solution. The process uses very little solution, and produces a damp-dry output.

#### Negative Working Diazos

The standard dye diazos are positive

working, that is, exposed areas are clear (on transparencies) or colorless (on opaque stock). In photographic terms, the copy is a positive duplicate of the original. A number of methods for making negative working diazos, which produce negative from positive originals are available. The best known of these processes, the vesicular process, is so widely used in display systems that it will be discussed in a separate section below.

Only two other processes of the many available will be discussed here. These have been selected for discussion, not because of their greater applicability to display technology, but because they are illustrative of the great variety of materials available in the current state-of-the-art of diazo technology, and yet are easily understood by the non-chemist. The rapid rate of advance in diazo technology is definitely comparable to that of silver-halide technology and new and potentially useful display materials are being developed at a rapid rate.

The auto-coupling, negative working diazos, not commercially satisfactory because of the critical exposure control required, depend on the fact that the ultraviolet decomposition products of certain diazos can serve as couplers for the same, or another, diazo. A controlled exposure can be used to partially destroy the diazo compounds in what would normally become a clear area. This permits these areas to darken through auto-coupling. An ultraviolet exposure is then used to destroy all remaining diazos, and a negative image is thus produced. High image contrast is still possible by using a combination of a fast diazo to produce the auto-coupler, and a slow diazo to produce the negative image.

The diazosulfonate negative materials depend upon the property that light (or heat) will restore the coupling capability to a diazosulfonate. Upon exposure to light through the clear parts of a negative the diazosulfonate will dissociate into diazonium and sulfite ions. Development in an alkaline coupler solution will then form a dye in the exposed areas and wash away the unexposed diazo sulfonates, leaving unexposed areas clear.

Some commercially available diazo sulfonate materials produce a low contrast pale yellow or orange image on a clear background. The image contrast is unsatisfactory for visual use, but the yellow areas have a higher ultraviolet opacity than most darker dyes; better second generation conventional diazo duplicates are thus possible with yellow intermediates, than with blue or black ones.

#### Thermal Diazos

Thermal diazos are processed by heat alone. The diazonium compounds and

the coupler are both in the emulsion layer but will react with each other only at elevated temperatures.

Thermal diazos in black on thin beige paper stock are well known because of their use in one class of office copying equipment, but newer thermal diazo materials on transparent and translucent, tinted stocks, with vivid colors, suitable for use in overhead projector graphic displays have been developed. Because computer generated print-outs on opaque paper can be converted to projectable transparencies by this process, the mechanism will be briefly discussed.

Unlike ordinary diazos, which require a one sided, translucent original, with ultraviolet-opaque markings, thermal diazos may also be used with opaque (even two sided) originals, provided only that the markings are infrared absorbing.

The printing process is a reflex contact printing process; that is, one in which the illumination passes through the thermal diazo on its way to the original. The coating and base material of the thermal diazo are translucent to visible and infrared radiant energy. A high energy lamp source is used and the incident radiant energy is absorbed in the opaque markings producing intense local heating, which is transferred by conduction to the thermal diazo emulsion, producing a duplicate image. The radiant energy from the clear areas of the original are reflected out and away. Simultaneously the ultraviolet component of the radiant energy decomposes the remainder of the diazonium compound so that it will be insensitive to further heating.

The obvious advantage of the thermal diazos over the conventional dye diazos is the dry development feature, involving neither liquids nor possible ammonia fumes. There is no theoretical reason why a satisfactory family of ultraviolet exposing, heat processing dye diazos suitable for display systems cannot be developed. The problems involved are primarily of a materials nature. To quote from Kosar (3):

"It is obvious . . . that to solve the problem of heat development of diazotype papers, it is necessary to employ a diazo compound of high thermal stability, azo components of high coupling energy, and alkali-generating agents which are stable at normal temperatures but which decompose rapidly and completely at the developing temperature. To make such a selection is not a simple task. The thermal stability of diazo compounds varies slightly according to their structure and they start to decompose around 120°C."

Development temperature must be high (on the order of 150°C), in order to permit image densities, comparable

to that of ammonia processed diazos, to form rapidly (within 5-10 seconds) before decomposition degradation takes place.

#### Vesicular Diazos

Vesicular materials are materials in which light scattering centers are established by exposure to radiant energy. The best known vesicular material is Kalvar, which employs a diazo sensitization, although vesicle images can be produced by photolytic decomposition of ferric ammonium citrate, photo-depolymerization of polyketones, and a variety of other photosensitive reactions.

The primary requirement for a vesicular material is a clear base, which can be locally ruptured to form microscopic light-scattering vesicles. In Kalvar, the diazo sensitizer is embedded in a thermo-plastic resin coated in a thin (0.012 mm) layer on a (usually) transparent polyethylene base. Exposure to near ultraviolet light frees nitrogen gas from the diazonium compound. The sudden application of heat at temperatures ranging from 80°C to 150°C for times ranging from fractions of a second to several seconds (time and temperature are not critical) causes the nitrogen to expand rapidly, thus rupturing the material.

The heat energy required to develop the image is on the order of 5 cal/cm<sup>2</sup>/mm (total thickness). The most convenient heat applicator consists of a pair of rotating heated metal rollers.

Following development, the material must be desensitized by uniformly exposing the processed image, and then permitting the released nitrogen to diffuse slowly at temperatures below 110°F. The image may, however, be projected immediately if the projection source is ultraviolet free, or if the temperature at the film gate is held below 110°F. The image is as durable as the base support material.

A reversed image can be produced by permitting slow diffusion after the first exposure, following this with an overall second exposure and heat development.

The speed of vesicular materials is generally considered to be three to five times that of the sensitizing material because the scattering cross-section, while still molecular in size, is larger than the original capture cross-section due to the gas expansion.

When viewed under transmitted light, as on a light table, the appearance of a vesicular image is that of a very low contrast (clear and translucent) negative of the original. When projected on a screen the image appears as a high contrast negative of the original. If the original were a silver halide negative image of bright characters on an otherwise unilluminated cathode-ray tube

face plate, the screen image would, of course, be a positive image of the cathode-ray tube display (bright characters on a dark background).

The contrast of the projected image is greater at smaller projection system (projection lens and condenser) apertures, but the highlight illuminance is then lowered.

The reason for the tremendous difference in projection and direct viewing contrast is due to the large ratio of specular and diffuse densities.

The translucent areas scatter light, rather than absorb it, when diffuse light (as from a light table) reaches the image from the rear; this causes the translucent areas to appear almost as luminous as the clear areas, hence a low image contrast. When nearly parallel light (as from a narrow aperture projection condenser) passes through the clear areas, nearly all of the transmitted light enters into the projection lens to reach the screen. The light passing through the translucent portion is scattered nearly uniformly through a hemisphere, and only the rays within the narrow angle subtended by the projection aperture will be able to reach the screen. Hence the projected image contrast is quite high.

When viewed by reflected light on a black background, the translucent areas appear a pinkish white, the clear areas appear black, and the image appears as a low contrast positive.

#### Photochromic Materials

Photochromic materials include both organic and inorganic compounds which can be cycled through color changes by applying energy in different spectral bands. The majority of the compounds are clear or colorless under white light (sunlight, daylight, tungsten, etc.), which contains a large proportion of infrared energy, and are dark after exposure to near ultraviolet energy. Of course the mere act of viewing the image in white light will cause it to fade, with the rate of fading depending on the particular compound and the amount of infrared energy contained in the white light. The use of a projection source free of infrared will permit longer persistence images. The persistence may be controlled by varying the proportion of infrared permitted to fall on the image.

Several colors are available, although not with closely matched persistence characteristics, and subtractive multi-color images are possible, either by physically sandwiching several sheets together (including a map background if desired), or by using a sequence of relay lenses which successively image one transparency upon the next. The latter approach is not practical for more than two transparencies (for example, a single map background and a single photo-

chromic transparency, because of the light losses inherent at each step).

Photochromic materials are negative working, with ultraviolet exposure, although there is no reason why they may not be prefogged with ultraviolet and selectively erased with infrared.

Photochromic materials have the major advantage of reusability, because the materials may be recycled many times; this factor alone would make their use appealing. An additional advantage in target tracking displays is the controllable image decay. In target tracking applications, each track will have a tail proportional in length to its velocity, and the disappearance of older portions of the tail as the target moves on avoids the clutter present in scribing projection displays.

Where this feature is not desirable, the disadvantage of image transiency outweighs the advantage of reusability. As will be noted below, certain electrostatic processes also offer erasability (although non-selective) and reusability, as well as greater sensitivity.

#### Electrostatic Processes

Electrostatic processes depend upon an increase in conductivity of certain materials (photoconductors) upon exposure to light. The two major classes of electrostatic processes are the transfer and the direct processes.

In the transfer process the latent electrostatic image is transferred from the light sensitive material to a receiving sheet which may be either opaque or clear; the latter material offers the possibility of preparing projectable transparencies. Offset and spirit masters may be directly generated by the transfer process. In the direct process the light sensitive material is coated on the paper or other support which will carry the final image. Since the available coatings are opaque, the direct process does not permit the direct preparation of transparencies.

In the transfer process the photoconductive material is most frequently a thin layer of vacuum-deposited vitreous selenium on an aluminum (or other metal) drum or plate.

The plate or drum is placed in a dark chamber and is sensitized by being moved past one or more fine wires biased, relative to the metal base, to a potential of 6000 to 8000 volts. Either positive or negative bias may be used; in the following discussion a positive potential will be assumed.

At these elevated potentials, a corona is formed about the wire(s) due to the high potential gradient. The surrounding air is ionized and the positive ions are driven from the wire to the photoconductive surface. The surface is uniformly charged to a potential of some 500 to 800 volts.

In total darkness the half-life of this charge is several hours; under high ambient illumination the half-life of the charge is measurable in seconds. The net result of a selective exposure, as from a cathode ray tube display, a transparency, or an opaque image, is to produce a potential or charge distribution pattern on the photoconductor surface.

The electrostatic contrast of the charge image (that is, the difference between the maximum and minimum potentials on the photoconductive surface) is a function of the contrast of the optical image, the time between sensitization and exposure, the exposure time, and the time between exposure and development. Obviously, contrast will be zero for both very short and very long exposures, there is thus an optimum exposure time for a given image luminance range. (Exposure requirements will be discussed in detail in the latter part of this chapter in the completed work.)

At this stage the latent image must be developed. One form of development consists in applying a solid toner bearing a charge opposite to that originally deposited on the photoconductor. Solid toners consist of micron-sized particles of fusible resin or plastic to which colored dyes or pigments have been added. One method for charging the toner particles is to use a two-component developer, in which the toner particles are mixed with larger particles, the carrier beads. Friction between the carrier beads and the toner particles creates opposite electrostatic charges on each, and the toner particles cling to the carrier beads. When the toner-coated carrier beads are spread over the latent image, the toner deposits itself at points of maximum charge gradient on the image. This method of development is most suitable for line copy or textual data; large dark areas do not develop satisfactorily.

The toned image is then transferred to its final support (paper, plastic, etc.) by contact, using a high potential charging system, similar to the one used for sensitization, to expedite the transfer of charge from the photoconductive material to the receiving material. Residual toner is removed from the photoconductive plate by brushing and vacuuming, so that it may be re-used. The transferred image is "fixed" by heat, to fuse the thermoplastic toner to the support. If it is desired to re-use the material, the heating may be omitted and the image erased by brushing away the toner.

Note that the process as thus described is not suitable for forming images of bright characters on a dark background cathode ray tube. Raster scan displays, with dark characters on a white raster, or photographic images with no large

Plug  
'em in!



Burroughs Sphericular  
Optic Readout Devices  
use 12 Hudson T-1 3/4  
TU-PIN Lamps mounted  
on a base less than 1" square!

## Hudson T-1 3/4 TU-PIN LAMPS ARE PROBLEM SOLVERS

### They fit where others won't go!

Designers like this lamp because its unique tapered base saves significant socket space, as in the Burroughs application above. Shorter than others too, yet with the entire filament above the base there is no sacrifice of light output. Hudson TU-PIN lamps plug right in from the front, making installation and service easy and eliminating any need for expensive sockets.

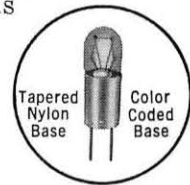

**ACTUAL SIZE**  
Up to .020"  
less diameter  
and .055"  
shorter than  
other TU-PIN  
type lamps.

### APPLICATION POTENTIAL

Suitable for components in readout devices, printed circuits, transistor protecting current-limiting devices, indicators and wherever sub-miniature lamps are used. As the first to make these lamps commercially available we have more experience with their application than anyone else. May we help you?

Write for new catalog.

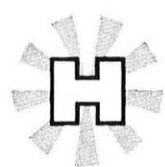

**Hudson LAMP COMPANY**

550 Elm Street, Kearny, New Jersey 07032

MINIATURE LAMP SPECIALISTS

Circle Reader Service Card No. 26

black areas will record in an acceptable manner. Screened halftone images which contain visible dot structure even in the densest areas will also reproduce satisfactorily.

Special techniques have been devised for the development of continuous tone images, or images with large solid areas. These involve the use of a development electrode and either powder cloud or liquid spray toners. These techniques also permit positive-to-negative as well as positive-to-positive processing, by proper selection of the potential on the development electrode, and the polarity of the toner charge (1). Multicolor images may be formed by successive transfers to the receiving material of properly toned images.

The direct electrostatic processes use paper or other supporting material coated with an insulating binder containing zinc oxide or some other photoconductive material. The material may be repeatedly resensitized and multicolored images may be formed by successive imaging and toning.

Neither the toner methods of development, nor the transfer techniques, are dependent upon the method by which the charge distribution has been established. Thus, they apply equally well to the direct beam recording methods described under the subheading "Direct Beam Recording", above. One development method, originally devised for direct beam recording, has also been adapted to processing photoconductive images.

In the thermoplastic recording process, development involves heating the thermoplastic base on which the charge pattern is stored. The base is held in contact with an oppositely charged metal plate. The material is softened by the heat and the attraction between the surface bound charges and the backing plate causes the surface to deform in accordance with the charge distribution. The resulting image is not directly visible to the eye, but may be projected with a Schlieren optical system (which converts the variations in refraction angles at the deformed surface into a variable luminance image at the screen). The image may be erased by reheating the thermoplastic base.

A closely related process is frost recording in which a nonerasable light scattering image is formed by heating the exposed photoconductive thermoplastic.

### References

1. Neblette, C. B. *Photography, Its Materials and Processes*, 6th Ed., D. Van Nostrand Co. Inc., New York, 1962.
2. Mees, C. E. Kenneth, *The Theory of the Photographic Process*, The MacMillan Co., New York, 1954.
3. Kosar, Jaromir, *Light-Sensitive Systems*, John Wiley & Sons, New York, 1966.

INFORMATION DISPLAY, SEPTEMBER/OCTOBER, 1966

# Interactive Displays For Document Retrieval

by H. Borko and H. P. Burnaugh

System Development Corporation

### Abstract

Interactive computer systems establish a dialog between the man and the machine. By means of displays, the user receives immediate feedback of the results of his actions, and he is able to modify his decisions in order to obtain a system response that is most relevant to his needs.

BOLD (Bibliographic On-Line Display) is an example of a highly automated interactive document storage and retrieval system that is in operation at System Development Corporation. It enables the user to browse through the data base by subject categories or search for specific documents. The response is rapid and the results are satisfying.

### The Problem

BOLD (an acronym for Bibliographic On-Line Display) was designed to be a highly automated and versatile document storage and retrieval system. The objective was not simply to automate, but through automation, to achieve a high degree of operational efficiency and user satisfaction.

The procedures followed in most existing retrieval systems are awkward and entail a considerable time delay. The user transmits his request to an information specialist who translates it into a search formula — a set of retrieval terms that are compatible with the index terms used in the information system. Retrieval is usually a two-step process in which document identification numbers are obtained. The results of the search are reviewed for reasonableness by the information specialist, and after a delay of hours or days, the material is sent to the requester. More often than not the user is annoyed by the delay he has encountered and is suspicious of the results achieved. He may receive some irrelevant documents and may not receive some relevant documents that he believes are in the system.

In contrast, a person gets a much greater feeling of satisfaction when he uses a traditional library. There, he may browse among the shelves selecting and examining books at random or in a given subject location. He may look through the card catalog under various subject headings seeking documents with promising titles. Finally, if he is not sure of the

INFORMATION DISPLAY, SEPTEMBER/OCTOBER, 1966

best way of searching for specific information, he may ask someone for help. It is important to note that a library search procedure is "interactive" in the sense that the user interacts directly with his data and receives immediate feedback on the results of his search. Unquestionably, this sense of direct contact contributes to the user's satisfaction and to the efficiency of the system.

The BOLD system was designed and programmed to provide the user of the computerized retrieval system with the same kinds of capabilities that he finds helpful when using a library. The desired characteristics are as follows:

- (a) Language must not be a barrier. Ideally, the user should be able to state his requests in natural English, or failing this, the computer should help him express his needs in an acceptable language. Certainly, the system would fail, if the user first had to learn programming before he could retrieve information.
- (b) The user must be provided with information about how documents are organized and classified within the system. He must be allowed to explore the content of these categories just as he would browse among the books on the shelves of a library or cards in a catalog file.
- (c) When preparing a search request for specific material, the user must be helped by the system to word this request correctly just as he would be helped by a librarian in a manual system.

In essence, a computerized document storage and retrieval system must make it easy for the human user to interact with the machine in order to retrieve relevant material and screen out irrelevant material. BOLD has been designed with these characteristics in mind.

### The System Environment

BOLD operates within the System Development Corporation (SDC) Research and Technology Laboratory. It is programmed for use with the IBM Q-32V computer and Time-Sharing System, a very large computer complex with a 64K word core memory and auxiliary storage on drums, discs, and tapes.

In practice, the user has no direct contact with the computer. He sits at



FIGURE 1: BOLD inquiry station.

one of more than a dozen user stations at SDC or at a remote installation. The inquiry station consists of a teletypewriter and a cathode-ray-tube display with a light pen.

- (c) Allows the user to formulate his requests in natural language with very few computer-oriented restrictions.
- (d) Displays retrieved information on a teletype or CRT console.
- (e) Copies the retrieved information on a magnetic tape for off-line listing.

The utility and versatility of these programs will be explained by describing the operations of the BOLD system.

### The Interactive Environment

BOLD is an interactive system, which means that a dialog is established between the user and the system so as to enable the user to request and obtain relevant documents from the collection. The requests and the system's responses are stated in as close an approximation to natural language as is possible. Ideally, the user with only a knowledge of the English language and a skill in typing should be able to establish a rapport with the machine. Although this ideal may never be fully achieved, a great deal of human engineering skill has gone into the project so that it could be approximated.

### Interactive Displays and the Browse Mode

The BOLD inquiry station consists of a teletypewriter and cathode-ray-tube display unit (See Figure 1). The user interacts with the system and requests information by typing on the teletypewriter. He may also make certain requests by using the light pen and the display scope.

After he has logged in and the data base and program tapes are loaded, the system reports this fact by typing . . . THIS STATION IS NOW UNDER THE CONTROL OF THE BOLD SYSTEM OPERATION INSTRUCTIONS R OBTAINED BY THE REQUEST: INSTRUCTIONS/ Simultaneously the display shown in Figure 2 will appear on the scope. This display defines the ten light-pen actions that are available to the user.

The user begins by flashing the "B" character with the light pen or typing BEGIN/ on the teletypewriter. Commands such as BEGIN, SEARCH,

The programming system has two major modules: (1) the data base generator program and (2) the display and retrieval program. Both are written in the JOVIAL language with some of the sub-routines in machine code (SCAMP). It is anticipated that these programs will be rewritten for the IBM 360/67 when this computer becomes available in the latter part of this fiscal year.

#### The Data Base Generator Subsystem

The BOLD data base generator builds tables of structured information from a Hollerith prestored magnetic tape. The tables are designed with extensive linking between entries referenced by identical key words or phrases to permit rapid retrieval. The data base that is presently being used was obtained from the Defense Documentation Center and consists of abstracts of approximately 6000 documents. For experimental pur-

poses, a subset of these documents is used. The particular tape from which the illustrative examples were derived consists of the first 1745 abstracts and 6883 retrieval terms. The documents are grouped into subject categories organized according to the DDC classification system. However, the program is flexible, and various classification and indexing systems can be used.

The function of the data base generator subsystem is to process prestored data tapes and to establish the linking between the index terms and other descriptive attributes such as authors, titles, contract number, etc. The data tables produced by the data base generator are used by the retrieval program. A technical description of the data base generator and of the display and retrieval subsystems has been prepared by Howard Burnaugh [References 1 and 2], who wrote the programs.

#### The Display and Retrieval Subsystem

As the name implies, the display and retrieval subsystem is designed to search the data base that has been structured by the data base generator program and to retrieve and display the requested information. Although this is a difficult enough task in itself, the interactive features make the programs even more complex.

The retrieval program has the following characteristics:

- Allows, and therefore monitors, many users who are interrogating the same data base but who are doing simultaneous, independent, real-time retrieval.
- Permits the user to interrogate the dictionary and find out whether a word has been used as an index term — and how often — and whether there are synonyms or related terms.



FIGURE 2: Initial tutoring display.

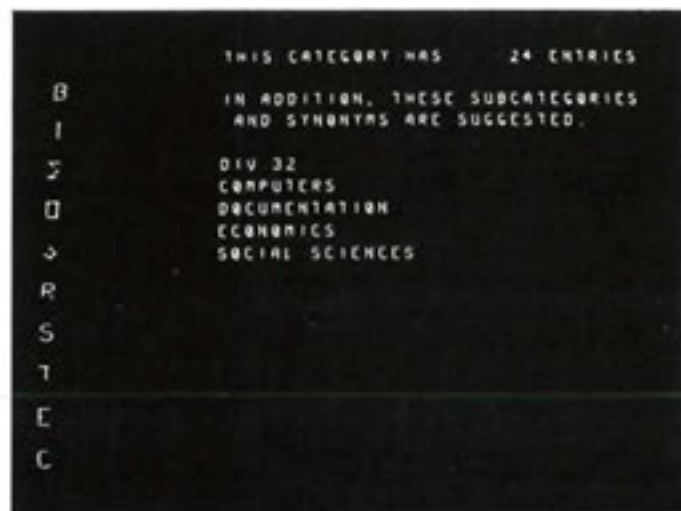

FIGURE 4: Subdivisions of category 32.



FIGURE 3: Classification categories.



FIGURE 5: An abstract displayed on SCOPE.

## Marco-Oak sales representatives

#### GRAY-WILLIAM ASSOCIATES

8 E. Mt. Vernon Avenue  
Haddonfield, New Jersey 08033  
Area Code 609-429-5300

#### HOLLINGSWORTH & STILL, INC.

3098 Piedmont Road  
Atlanta, Georgia 30305  
Area Code 404-261-5838  
1010 Executive Center Drive  
Orlando, Florida 32803  
Area Code 305-241-5401  
6717 Woodstock Drive  
Charlotte, North Carolina  
Area Code 704-532-3327

#### JACK F. MCKINNEY SALES CO.

1303 Chemical Street  
Dallas, Texas 75207  
Area Code 214-631-9450

#### LLOYD F. MURPHY & ASSOCIATES

730 Chicago Avenue  
Minneapolis, Minnesota 55415  
Area Code 612-333-4511

#### RICHARD PURINTON, INC.

11 Muzzey Street  
Lexington, Massachusetts 02173  
Area Code 617-862-8300  
Ross Bower  
P.O. Box 12  
Colebrook, Conn.  
Area Code 203-379-2501

#### HENRY G. RICHTER, INC.

1376 U.S. Highway No. 22  
Mountainside, New Jersey 07092  
Area Code 201-AD3-4615  
P.O. Box 251  
Fayetteville, New York 13066  
Area Code 315-637-6713

#### I. W. STRONG & ASSOCIATES, INC.

635 Canosa Court  
Denver, Colorado 80204  
Area Code 303-292-6900, 1, 2, 3

#### T. R. VAN WAGONER COMPANY

73 West Truman Avenue  
Salt Lake City, Utah  
Area Code 801-HU6-7251

#### M. K. WIDDEKIND CO., INC.

815 West Ewing Street  
Seattle, Washington 98119  
Area Code 206-284-8020

#### ROBERT BARTOS

804 East Essex  
Glendale, Missouri 63122  
Area Code 314-964-9594

#### WILLIAM COLE

838 Carini Lane  
Cincinnati, Ohio 45218  
Area Code 513-771-4491

#### J. W. SHEFFER

4609 Old Frederick Road  
Baltimore, Maryland 21229  
Area Code 301-CE3-0606, 7

#### MARCO-OAK INDUSTRIES

207 South Helena Street  
P.O. Box 4011  
Anaheim, California 92803  
Area Code 714-535-6037

#### MARCO-OAK INDUSTRIES

4546 El Camino Real Suite "D"  
Los Altos, California  
Area Code 415-941-1237

#### OAK MANUFACTURING CO.

Crystal Lake, Illinois  
Area Code 815-459-5000  
John Kent  
George Kongabel  
Richard Schneider  
James Wells



## MISSILITE "MIX OR MATCH"...

### solves your panel indication problems

Creative design results when your panel is planned with Missilite® Indicator Lights. Clean, compact and functional, they give your panel effective presentation, reliable operation, flexibility in arrangement and reduced maintenance costs. Available in a wide variety of sizes and shapes. They offer further options . . . single or multiple array (horizontal or vertical), choice of legend colors and styles, two- or three-lamp reliability, parallel or individual lamp operation. Also, "Press-to-test" feature, R.F.I. shielding, lamps or legend plates removable and replaceable from front of panel. Get help with your panel design, write today for the Missilite Catalog.



MARCO-OAK INDUSTRIES

A DIVISION OF OAK ELECTRO/NETICS

207 SOUTH HELENA STREET, ANAHEIM, CALIFORNIA 92805

PHONE: 714-636-6037 • TWX: 714-776-6111

Circle Reader Service Card No. 23





## At Monmouth Medical Center, SYSTEM/360 checks in—checks out...

George Bartel, Hospital Administrator, has big plans for Monmouth Medical Center, Long Branch, New Jersey. That's why SYSTEM/360 is there.

Just a few weeks after its arrival, SYSTEM/360 took over patient billing, and went on to automate all administrative paperwork.

Nine more days, and SYSTEM/360 converted the process to direct-access disk files. An easy transition with IBM SYSTEM/360 Basic Operating System (BOS/360 for short).

After information is entered, it can be processed in microseconds.

This opens an entirely new realm of operations—a real-time Hospital Information System.

A complete information hookup is planned. Keyboard communications will connect SYSTEM/360 to vital areas—nurses' stations, X-ray, pathology, pharmacy and others.

New information can be entered immediately. Services ordered and validated. Treatments reviewed by instant printout. Drug control data displayed. Resources scheduled and allocated.

The goal—the most efficient use of facilities and time.

Monmouth Medical Center is growing. And SYSTEM/360 is ready to meet this growth, because the System's modular design makes it easy to expand, to solve more problems, to take on more information-handling chores.

Monmouth Medical Center likes its IBM SYSTEM/360.

So do hundreds of other companies in all kinds of industries.

They like its performance, speed and versatility.

We think you will, too.

# IBM®



and starts a new era.



BROWSE, CONTINUE, etc., must be followed by a slash. One uses a question mark to ask for help, and for all other interactions no punctuation marks are used.

When the slash is not used the requester types

BEGIN  
the system responds

\*NOT FOUND  
The system is interpreting the word BEGIN as an index term. Since such a term has not been used, the system responds with \*NOT FOUND. The user, recognizing his error, tries again, this time by typing

BEGIN/  
This command is accepted (signified by //), and a new display appears (Figure 3) that indicates the 32 divisions or main subject categories into which the data are divided. If the user wishes a further breakdown, he may use his light pen to flash a division. By doing so, he is requesting more information about that category and receives a display of the subdivisions (Figure 4). The display also supplies the number of entries in the category. If he chooses to browse through the items in this category, he may do so by flashing the  character with his light pen or by typing BROWSE/ on the teletype writer.

The display he would receive is the first abstract in that category (Figure 5).

Usually, when dealing with a large collection of documents, one is not likely to want to browse through all the documents in a category. However, it is conceivable, especially when the document collection is organized in a hierarchical classification schedule such as the Dewey Decimal System, that browsing by category will be useful; this capability is therefore provided.

Dictionary Interrogation  
and the Search Mode

A more common method of seeking information is to request documents by subject headings or index terms. Many information centers use a form of coordinate indexing and retrieve information by combining a number of index terms to form a specific request. Usually a trained information specialist must help the user formulate his request for information into a search request made up of approved index terms. In an interactive system, the user requests help by interrogating the dictionary.

By way of illustration, let us suppose the user is doing research in the field of space travel. He is preparing a report on this subject and he wishes to search the collection for relevant articles. He sits at the inquiry station, and after the

system is in operation he begins by interrogating the dictionary to determine which words can be used as index terms for retrieval purposes.

The following dialog takes place:  
SPACESHIPS?

THESE MAY BE RELATED TO  
SPACESHIPS  
SPACESHIP CABINS  
SPACESHIPS  
SPACESHIPS - POWER SUPPLIES  
SPACESHIPS - STABILITY

\*END  
SPACE?  
THESE MAY BE RELATED TO  
SPACE

SPACE CAPSULES  
SPACE CHARGES  
SPACE ENVIRONMENTAL  
CONDITIONS  
SPACE FLIGHT  
SPACE FLIGHT - CONTROL  
SPACE FLIGHT - SURVIVAL  
SPACE MEDICINE  
\*CONTINUE?YES  
SPACE MEDICINE -  
EFFECTIVENESS  
SPACE NAVIGATION  
SPACE PERCEPTION  
SPACE PROBES  
SPACE RECOVERY SYSTEMS, INC. -  
EL SEGUNDO, CALIF.  
SPACE SCIENCES LAB., GENERAL  
ELECTRIC CO., PHILADELPHIA,  
PA.

SPACE SHIPS  
\*CONTINUE?NO  
LUNAR FLIGHTS?  
\*NOT FOUND  
MOON FLIGHTS?  
\*NOT FOUND  
MARS FLIGHTS?  
\*NOT FOUND  
MOON?

THESE MAY BE RELATED TO  
MOON  
MOON  
MOON - ATMOSPHERE  
\*END

LUNAR?  
THESE MAY BE RELATED TO  
LUNAR  
LUNAR PROBES  
\*END

MARS?  
THESE MAY BE RELATED TO MARS  
MARS  
MARSH CHARLES A.  
MARSHALL JOHN M.  
\*END

He begins by asking whether SPACESHIPS is an index term. He types in the word followed by a question mark. The system responds that in addition to SPACESHIPS there are a number of other similar terms that are also usable index words. The system finds these related terms by diving the query word in half and locating all index terms that start with the same combination of letters.

INFORMATION DISPLAY, SEPTEMBER/OCTOBER, 1966

	61 ENTRIES 37 SEARCHED	1 SPACESHIPS	2 LUNAR PROBES	3 MOON	4 MARS	5 SPACE FLIGHT	6 SPACE PROBES
B							
I							
Z							
D							
R							
S							
T							
E							
C							

FIGURE 6: Search matrix of retrieved documents.

The user, now recognizing that the term SPACESHIPS might be too specific, asks for information about the more general term SPACE. Again the system responds with similar terms. Note that the word SPACE by itself it not an index term for it is always used in combination with another word. In response to a dictionary inquiry, the system types seven index terms and then asks the user whether he wishes it to continue.

SPACE SHIPS OR LUNAR PROBES OR MOON OR MARS

25 ENTRIES ARE REF'D BY  
6 ENTRIES ARE REF'D BY  
13 ENTRIES ARE REF'D BY  
3 ENTRIES ARE REF'D BY

\*END  
SPACE FLIGHT OR SPACE PROBES  
15 ENTRIES ARE REF'D BY  
8 ENTRIES ARE REF'D BY

\*END  
SEARCH/  
51 ENTRIES

After two such inquiries, the user feels he has enough information on this subject and tries some other terms. Some of the words he tries are not index terms, but in his interaction he finds enough that are.

As a result of this dialog, and with the information he has obtained, he is now in a position to formulate a search

INFORMATION DISPLAY, SEPTEMBER/OCTOBER, 1966

```
AD-276 564  
AD-273 136  
AD-272 902  
AD-283 284  
AD-273 085  
AD-276 082  
AD-286 137  
AD-281 910  
AD-274 052  
AD-272 340  
AD-271 941  
AD-286 868  
AD-276 833  
AD-270 973  
AD-284 268  
AD-276 535  
AD-276 322  
AD-283 245  
AD-276 467  
AD-274 742  
AD-276 204  
AD-278 130  
AD-272 550  
AD-272 018  
AD-273 417  
AD-271 913  
AD-277 356  
AD-270 955  
AD-272 977  
AD-274 668  
AD-272 342  
AD-272 119  
AD-284 501  
AD-284 428  
AD-284 119  
AD-283 025  
AD-271 747
```

FIGURE 7: Viewing the retrieved abstract.

51 ENTRIES  
Since there is a total of 70 documents which have been indexed by these six terms, it is clear that some documents were indexed by more than one.

The system locates these 51 documents and displays the list by identification number and index term. This display appears on the scope (Figure 6). Note that all the documents are not able to be displayed at one time. Of the 51 entries only 37 have been searched. The user may now remove references to the documents that are of lesser interest. He does this by light-penning "R" and the document number. By light-penning the "C", or continue character, new document references will be displayed. He may also reorder the arrangement of the display by light-penning the "E" character and two document numbers that he wishes to exchange.

Let us suppose that in this case the user decides that he is more interested in space flight to Mars than he is in lunar probes. Probably document #AD-276082, which contains the terms SPACESHIP, MARS, and SPACE FLIGHT, is of most interest. He moves it to the head of the list by exchanging its location with the document that was previously first.

Should the user decide to keep a permanent copy of the display for future references, he types  
TYPE DISPLAY/  
and the information is transferred from the scope to the teletype. This information would be identical to Figure 6 except for the subsequent exchange that has been made.

Before requesting copies of the 51 documents that have been indexed by one or more of the six retrieval terms, the user would like to have more information about their contents. He may obtain this information by simply typing

SEARCH/  
and the system responds that there are

INFORMATION DISPLAY, SEPTEMBER/OCTOBER, 1966



## VACTEC PHOTOCELLS

Vital Components in the Electronic Scoreboard that Electrifies Sports Fans in Houston's Fabled \*Astrodome

Do they go to the Astrodome to see the game, or to enjoy the scoreboard? This \$2,000,000 electronic marvel puts on a show that really turns a crowd on. And Vactec is proud to be selected as supplier of approximately 11,000 matched cadmium sulfide photoelectric cells that are an integral part of the picture transmission system.

Specifically, the varying sensitivities of the Vactec cells control the brightness of the individual lamps

that transmit images on the scoreboard's huge center TV screen. Another example of Vactec's versatility and skill in the design and production of precise photosensitive devices.

Vactec provides a complete line of Se photovoltaic cells as well as CdS and CdSe photoconductive cells. Or Vactec will custom-design a unit for your application.

\* Used by permission of Houston Sports Assn., Inc.

VACTEC INC. 2423 Northline Industrial Blvd., Maryland Heights, Mo. 63045  
Area Code 314, HE 2-4200

Circle Reader Service Card No. 24

# Seventh National SID Symposium

**Attendance of 1000 Anticipated  
For Boston Meeting Nov. 18-20**



An estimated 1000 persons vitally concerned with Information Display technology will attend the 7th National Symposium of the *Society for Information Display* at the Hotel Bradford, Boston, Mass., Oct. 18-20.

According to Glenn Earl Whitham (Raytheon Co.), General Symposium Chairman: "We have had excellent response to our call for papers. This has enabled us to select an authoritative group of papers. In fact, we have dropped some we would have liked to utilize."

Glenn Earl Whitham



General Chairman  
7th National SID Symposium

"As a result of the fine selection of technical papers available, the program committee has inaugurated the procedure of selecting four standby papers, which will be published in the *Proceedings* whether or not the papers are presented."

"Regarding the *Proceedings*, we are hopeful that they will be available for distribution at the Symposium for the first time in *SID* history."

Theme of the Symposium is "Information Display as an Emerging Discipline".

All activities are centered in the Hotel Bradford, which is located in the heart of Boston's theatre district.

## Technical Papers

Robert C. Shuppert (Raytheon), Symposium Papers Chairman, has announced plans for six sessions at which thirty-two technical presentations will be made.

Technical Session hours are 10 a.m. to noon and 2 to 5 p.m. on Tuesday, Oct. 18, and 9 a.m. to noon and 1:30 to 4:30 p.m. on both Wednesday, Oct. 19, and Thursday, Oct. 20.

## Exhibits

According to Frederic C. Hills (NASA/ERC), Symposium Exhibits Chairman, early exhibits registrants included Sylvania, Litton, Celco, Image Instruments, Corning Glass, Polaroid, Adams, Beta Instrument, Thomas Electronics, and others.

Exhibit hours are 10:30 a.m. to 9 p.m. on Tuesday, Oct. 18; 9 a.m. to 9 p.m. on Wednesday, Oct. 19; and 9 a.m. to 6 p.m. on Thursday, Oct. 20. Exhibits will also be conveniently located at the Bradford.

## Field Trips

John Ward (of Project MAC) has arranged a field trip to the MIT Multiple Access Computer, and another, possibly to a major electronic military installation in the Boston area, is being arranged.

## Luncheon & Banquet

The Keynote Luncheon follows the morning technical session on Tuesday, Oct. 18.

The annual banquet will be the evening of Wednesday, Oct. 19, following the customary cocktail party. Entertainment is planned for the banquet.

These are the only two formal dining activities during the Symposium.

## Ladies' Program

The following arrangements are being made for ladies visiting the Symposium with their husbands:

**TUESDAY:** Coffee in the morning; a special luncheon at a Boston restaurant of interest; and a specially-arranged session on cosmetics and makeup in the afternoon.

**WEDNESDAY:** A sightseeing tour through Old Boston's historic suburbs, including Lexington and Concord, with luncheon at The Wayside Inn.

**THURSDAY:** A sightseeing tour through New Boston, including the Prudential Tower, followed by a theatre-matinee in the afternoon.

## Symposium Officials

In addition to those mentioned above, Symposium officials include Lester C. Smith (President, Image Instruments), General Symposium Co-Chairman - Program; Joseph E. Bryden (Raytheon), General Co-Chairman - Arrangements; Robert T. Schwartz (Raytheon), Chairman, Publicity and Registration; Harry Poole (Raytheon), Recording Secretary; and Norman E. Fine (President, Beta Instrument), Financial Chairman.

## Proceedings

7th *SID* Symposium *Proceedings* are available to all *SID* members without charge, and to others at \$15 per copy (from Western Periodicals, North Hollywood, Calif.).

## Technical Papers

Six technical sessions are planned, at which a total of 32 papers are available

INFORMATION DISPLAY, SEPTEMBER/OCTOBER, 1966

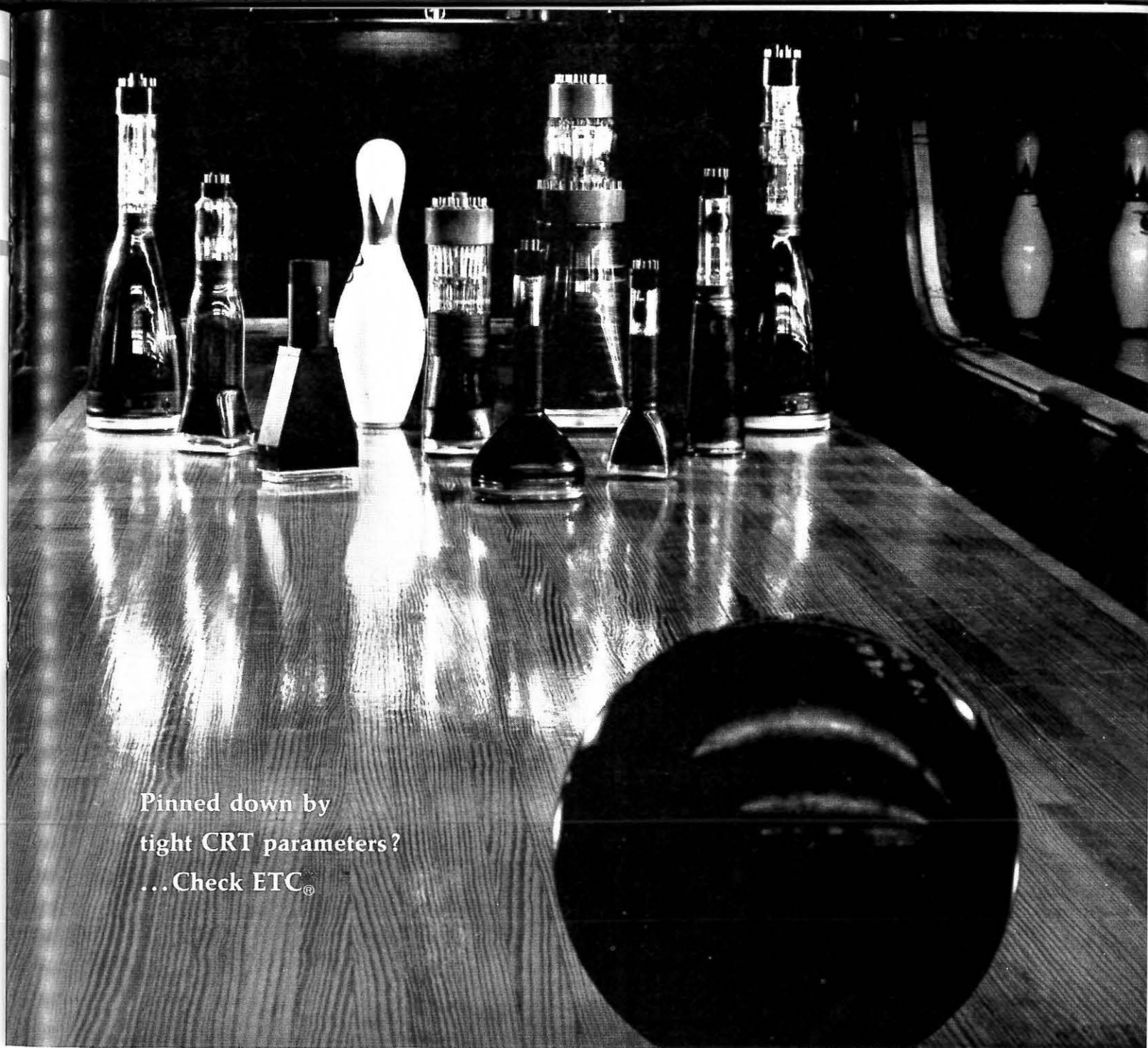

Pinned down by  
tight CRT parameters?  
... Check ETC®

## Tube capability is right down our alley

Challenge has been our game for nearly 30 years . . . the challenge of designing, building, and testing special CRT's for special applications. We meet this challenge, continually, through the know-how and creativity of our champion CRT research team, comprising some of the most advanced minds in the technology.

From our modern research and development facilities have come many "firsts" in CRT development. Electrostatic deflection plates, aluminumized screens, reticular optics, and flying spot scanners are some of our pioneering achievements. And our contributions to industry, science and the military have earned us a reputation for solving particularly difficult tube problems.

Today, in addition to virtually unlimited capability in special CRT design, we offer the largest variety of off-the-shelf tubes in the industry. Each has undergone the quality-controlled product engineering and stringent testing required as a custom fabricated item. And each will provide more display per dol-

lar in the application for which it was designed. Try pinning us down to your individual CRT needs, whether they involve multi-layer phosphors, special shapes, ultra high resolution, or multi-guns. You'll find us "right down your alley" when it comes to meeting your specs. Why not call us today . . . or write for our complete capability story.

lar in the application for which it was designed.

Try pinning us down to your individual CRT needs, whether they involve multi-layer phosphors, special shapes, ultra high resolution, or multi-guns. You'll find us "right down your alley" when it comes to meeting your specs. Why not call us today . . . or write for our complete capability story.

**GENERAL  
ATRONICS**  
ELECTRONIC TUBE DIVISION  
PHILADELPHIA • PENNSYLVANIA 19118





**The new Ultrabright**  
illumination system, developed for SELECTROSLIDE 2 x 2 slide projectors, delivers twice as much illumination as presently available Xenon slide projector modifications; four times as much as previous Selectroslide models; six times as much as 500-watt projectors. Now available on all "SL" series SELECTROSLIDE projectors except the SLM. Write for complete information.



 spindler & sauppé inc.  
1329 grand central  
avenue / glendale  
california / 91201

for presentation. These are:

SESSION I: *Display Devices and Techniques - I.* Chairman is John E. Ward, Assistant Director, Electronic Systems Laboratory, Massachusetts Institute of Technology.

SESSION II: *Information Processing as a Function of Display Format.* Chairman is Dr. Dwight E. Erlick, USAF Behavioral Sciences Laboratory, Wright-Patterson AFB, Dayton, O.

SESSION III: *The Observer: Human Factors and Performance.* Chairman is George Grant, Managing Scientist, Dunlap and Associates Inc.

SESSION IV: *Display Devices and Techniques - II.* Chairman is Alvin S. Luftman, Program Manager, Display, Storage and Industrial Tubes, Industrial Components Operation, Raytheon Co.

SESSION V: *Display Systems.* Chairman is Ben Warringer, Principal Engineer, General Dynamics Electronics.

SESSION VI: *Display Standards and Measurements.* Chairman is Dr. Carlo P. Crocetti, Chief, Display Techniques Branch, Rome Air Development Center.

Papers to be presented at the various sessions include:

#### Session I

*Non-Linear Optical Filters*, by Kenneth P. Lally, Senior Staff Engineer, Huyck Systems Co.

ABSTRACT: A new class of composite optical filters has been developed which exhibits markedly different transmission properties in opposite paths through the filter. In one direction, optical energy may be efficiently transmitted with only moderate effective attenuation. In the opposite direction the filter will almost totally absorb optical energy, with negligible specular or diffuse reflection. These "easy" and "hard" transmission characteristics inevitably draw comparisons to a "diode" for energy transfer at optical wavelengths.

The unusual transfer function of these filters is obtained by a combination of both active and passive optical media and in part exploits the irreversible emission properties of fluorescent materials. The paper will present a theoretical model of such a filter and will analyze its physical behavior in terms of simple classical optics theory. This work is being supported by National Aeronautics and Space Administration, Electronics Research Center.

*Application of Thermochromic Materials in Display Devices*<sup>1</sup>, by R. P. Borkowski, L. N. Finnie, M. Kornblau, D. Grafstein, and E. Hilborn, Aerospace Research Center of General Precision Inc., and NASA/ERC.

ABSTRACT: The feasibility of using thermochromic materials in display devices is currently under study. These

materials exhibit color changes when heated and revert back to their original color when cooled. The observation of the color change depends on a change in reflection and not on the emission of light, as is the case in electroluminescent materials. Thus, displays utilizing thermochromic materials are visible under wide ranges of ambient illumination. Two prototype numeric display devices have been constructed in which pure ternary compounds, Ag<sub>2</sub>HgI<sub>4</sub> and Cu<sub>2</sub>HgI<sub>4</sub>, were used as the thermochromic display materials. These prototypes gave high contrast images and demonstrated the feasibility of devices of this kind. Various new thermochromic materials have been prepared. Some of the more important properties of thermochromic materials, such as their stability, reversibility, thermodynamic characteristics and contrast will be presented. Experiments will also be described in which a laser beam was employed to "write" on a thermochromic material, and others in which the thermochromic material was substituted for the phosphor in a cathode ray tube.

*A Solid-State Matrix Display Employing Gallium Phosphide Diodes*, by A. Kawaji and H. Shiraki, both of Semiconductor Division, and T. Ando and T. Okubo, both of Central Research Laboratories, all of Nippon Electric Company Ltd., Tokyo, Japan.

ABSTRACT: This paper describes a solid-state diode matrix display employing Gallium Phosphide light source, which has been devised to investigate the possibility to be used as a solid-state display.

The matrix is composed of 4 (row), 5 (column) diodes, which emit the light of about 7000 Å in wavelength with a quantum efficiency of about 0.5% when forward biased by 4-8 volts while they hardly do when back biased below 8 volts.

By making use of the above mentioned characteristics of light emissive properties, the diode matrix was scanned by two separate scan generators for a row and column lines, respectively. Characters, 0 to 9, were successfully displayed on this device by a row pulse and signals from "And Gate" of column and character generator signals.

According to the experiment with this display device, the scanning speed per one word is 40 μsec and light intensity of a diode is 30 foot-lambert at the current of 80mA.

As far as the characteristics of light emission from GaP diode, it is shown that the color changes continuously from red to green with the increase of current as well as the doping conditions with donors and acceptors.

#### Session II

*Development and Evaluation of an*

INFORMATION DISPLAY, SEPTEMBER/OCTOBER, 1966

*Aircraft Photochromic Pictorial Navigation Display*, by James E. Brown, Bunker-Ramo Corp.

ABSTRACT: This paper describes the development and application of a photochromic display device for the purpose of presenting aircraft navigation and landing information. The device was of the rear-projection type. The display screen consisted of a six by eight inch screen upon which the simulated track of an object such as an aircraft was displayed. The track appeared as a small dark moving comet-like trace which was superimposed over any one of six background slides. These background slides were used to present the navigation displays. Development of the navigation slides for use in the display was predicated upon considerations of the vehicle performance, mission requirements and the equipment limitations. The rationale for the development of the navigation display slides is discussed.

Once the navigation displays were developed and fabricated, the photochromic display device was used in the Mark IV System Test. The Mark IV System was a simulator research aircraft system which utilized many new display-control concepts.

Results of the Mark IV System Test are compared with those of another similar but separate study. The implication of this comparison is that pictorial navigation displays of the type developed for the photochromic display hold a high degree of promise for the aircraft situation. The problems of developing these displays to realize their full potential is one which the hardware engineer and the display designer must work together to solve.

*The Interaction of Display Mode and Keying Performance*, by Dr. Richard L. Deininger, Bell Telephone Laboratories.

ABSTRACT: Initially, the studies relating to the interaction between the characteristics of the display and the speed and accuracy of keying will be reviewed. Emphasis will be placed on the importance of population stereotypes regarding the relation of the display and the responses in determining performance. Then the discussion will turn to the relation of keying speed and accuracy to display characteristics and to human short term memory. A study will be reported in which the display mode produced significant and large differences in keying performance selecting the characteristics of human short term memory.

*Evaluation of Probabilistic Displays*, by Dr. George N. Ornstein, North American Aviation, Columbus, O.

ABSTRACT: Many situations in which humans are required to act are probabilistic in nature. That is, the human is required to respond in a situation where he is presented with uncertain or fallible information display, SEPTEMBER/OCTOBER, 1966

information. In such a situation, it may be useful to present information to the human using a display in which the essential probabilistic structure of the information is preserved and explicitly presented. This paper presents a study of four different probabilistic displays. The effectiveness of operators in estimating probabilities using these displays and in making decisions with such displays is evaluated and compared with the effectiveness of operators using a non-probabilistic (conventional) display. The results support the feasibility of probabilistic information presentation.

*Constructing Data Pictures*, by Dr. Ronald M. Pickett, Harvard University School of Public Health, and Dr. Benjamin White, Lincoln Laboratory, Massachusetts Institute of Technology.

ABSTRACT: The use of graphic displays for presenting data to human observers is well known and documented. The advantages appear to be due to the fact that measures can be sensed more directly when shown as geometrical properties in some physical model than when presented in the form of arbitrary symbols. If we represent a measure by its conventional symbol, "2" for example, it is in no visible sense half of four or one-third of six, but when it is represented by a length of line or by the position of a point it is. Conventional graphic displays are largely limited to the "length of line-position of point" approach. This has been partly a matter of habit, but mostly a matter of convenience and economy. Large amounts of data from many research disciplines, however, has forced us to explore for some more global graphic techniques. Developments in computer graphics have made a number of new approaches economically feasible. The present paper will suggest some new approaches to graphic displays in which data measures control a wide variety of geometrical properties in a data picture. The resultant displays may take on the appearance of some substance or process, and the subjective "data analysis" may be in the form of certain physical descriptions of the display such as descriptions of its softness, flexibility, jaggedness, bushyness, etc. Some static and dynamic examples of such displays will be presented.

*Display Design Standards Based Upon Human User Requirements*, by Dr. Walter F. Grether, USAF Behavioral Sciences Laboratory, Wright-Patterson AFB.

ABSTRACT: For information displays to serve their purpose of communicating information they must be designed to match human capabilities for information reception and comprehension. Available data about human visual and perceptual capabilities, and the design of displays to match these, is being compiled into a revised chapter on "Vis-

#### PERIPHERAL DATA-PROCESSING INSTRUMENTATION

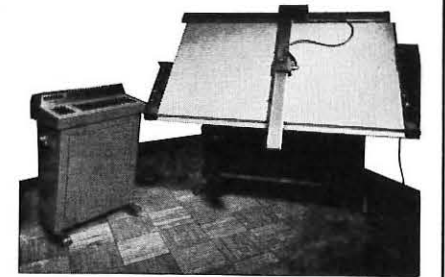

X-Y Measuring and Recording



Digitize Measuring Instruments such as Optical-Train Stereoplotters, Comparators, and Coordinatographs.

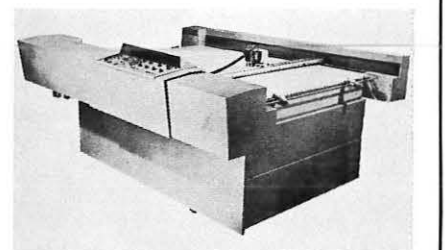

X-Y Coordinate Plotters

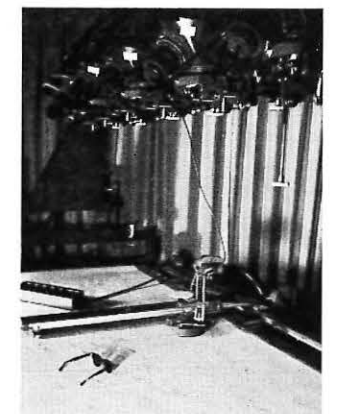

X, Y, Z Measuring and Recording in Photogrammetry

**Auto-trol CORPORATION**  
DIGITAL GRAPHIC AND DATA SYSTEMS  
5555 HARLAN, ARVADA, COLO. (303) 421-3788

ual Presentation of Information" for the *Human Engineering Guide to Equipment Design*. These handbook data will cover the subjects of: (1) General Display Principles; (2) Visual Detection, Identification, and Estimation; (3) Workplace Illumination; (4) Visual Coding; (5) Warning and Signal Devices; (6) Mechanical Indicators; (7) Electronic Displays; (8) Printed Materials; and (9) Projection Displays. This paper will describe the status, objectives, and general content of the handbook chapter. It also will give selected samples of the types of data and design recommendations it will provide. ●

#### Session III

*Extending Image Reproduction System Analysis to Include the Observer*, by Calvin K. Clauer, International Business Machines Corp.

**ABSTRACT:** Information display systems can be roughly classified as either image reproduction or image synthesis systems. The image reproduction systems produce a visual display which is an analog reproduction of an existing source pattern as exemplified by photographic projection and closed circuit television displays. The technique of employing a modulation transfer function (MTF) to characterize image reproduction systems of all kinds has been found to be very useful for performing predictive analysis. While such analytical methods are effective for characterizing physical image systems, they have not provided quantitative evaluation of the display from the observers' viewpoint.

By plotting the contrast threshold function of a "standard observer" on the same coordinates as the system modulation transfer function, difference values can be obtained which represent the objective physical modulation transfer (or contrast) above threshold. A rationale is presented for employing the renoted Munsell value scale as a psychophysical response scale in this supra-threshold region. The procedure for converting the physical modulation levels above threshold to this psychophysical response scale is described. Finally, the advantages of this procedure are demonstrated by examples. ●

*Evaluation of some Display System Parameters with Human Performance Measures*, by Calvin K. Clauer, A. S. Neal, and R. L. Erdmann, International Business Machines Corp.

**ABSTRACT:** The physical parameters which affect display "quality", such as screen luminance and contrast, are well known and readily measured. However, display system designers need to know how the user of the display, the human observer, will perform as a function of many display parameters. Traditional human factors literature is helpful, but such sources usually treat the human

visual process at threshold levels and typically consider only one of the many physical parameters at a time. Therefore, human performance measures are generally necessary to evaluate the effects of specific parameters in the supra-threshold situation of complex real display systems. Subjective judgments, such as preferences for various physical parameters, can also be obtained, but such criteria show high variability and are frequently misleading. ●

In a study conducted with a rear projection teaching machine, human performance measures were used to evaluate certain display parameters. The physical parameters of screen luminance, ambient illumination and image polarity (positive or negative) were investigated.

In another study, television displays were compared to film displays to determine points of equal "quality". The physical parameters were character size, television bandwidth and film image size. The human performance measure was legibility, i.e., the percent of correctly identified letters. Preference information was also obtained which clearly demonstrated the discrepancy which is often found between subjective judgments and objective performance measures. ●

*Pulfrich Space Form*, by H. B. Tilton, Optical Electronics Inc.

**ABSTRACT:** A little-known stereo effect, the *Pulfrich stereophenomenon*, is capable of producing stereo depth from single displays in a dynamic situation. A virtual depth excursion is generated by a stimulus point (target) moving horizontally, when the observer receives unequal binocular retinal illuminances (obtained, for example, by viewing with a neutral density filter before one eye).

The effect is attributed to the existence of a significant time delay between retinal stimulation and receptor response, and the resulting *differential delay* that exists when viewing a la Pulfrich. This differential delay in a dynamic display produces a retinal image disparity resulting in stereo depth. The subjective space form so produced is the *Pulfrich space form* (PSF).

Indications are that applications may exist for the Pulfrich effect in some areas of 3-D data display. ●

*Human Factors in the Design of Airborne Television Displays*, by Miss Beverly M. Hillman, Aerospace Systems Div., Radio Corporation of America.

**ABSTRACT:** Recent advances in the capability of electro-optical imaging system, particularly with respect to light sensitivity, have caused an increasing interest in television displays for military aerial operations. Each type of mission calls for its own particular design characteristics to optimize operator effectiveness. This paper will discuss the variables

involved in television viewing related to visual interpretation.

The principal variables which must be considered are: (1) The mission characteristics, (2) The imaging system, including contrast rendition, line coverage and signal-to-noise properties, (3) Human visual capabilities, in terms of resolution and contrast perception and search time, and (4) viewing conditions such as kinescope size and shape and the ambient environment. ●

*Some Problems in the Display of Information for Weather Forecasting*, by Donald B. Devoe, Applied Research Laboratory<sup>2</sup>, Sylvania Electric Products Inc.

**ABSTRACT:** Weather forecasting represents a type of data processing characterized by large amounts of heterogeneous data that must be analyzed rapidly as a basis for critical decisions. The pre-processing and display of this information in a form suitable for interpretation and prediction by the forecaster merits more study, particularly in the light of recent advances in the techniques of computer-aided analysis and display. This paper discusses the nature of today's visual aids to forecasting, some of the strengths and weaknesses of these aids, and the potentialities of adapting advanced concepts of data display to weather forecasters' requirements, as revealed in a survey of Air Force weather forecasters. The results of a pilot study are reviewed and discussed. The study involves an optical simulation of a possible advanced weather forecaster's console that permits the forecaster to select aids by pushbutton action, with capabilities for some superposition and animation. The reactions of experienced weather forecasters to this capability are summarized. Potential problems for future research are discussed. ●

*Numerical Displays Evaluation* (STAND-BY PAPER), by H. J. Caulfield, Texas Instruments Inc.

**ABSTRACT:** Displays forming a part of a complex system serve the purpose of transferring information to a viewer. The viewer acts on the basis of received information. Even if his reaction is perfect (i.e., if we postulate an ideal viewer), his actions may have a detrimental effect on mission performance if he has not received the proper information. The effect of mistransfer of information on mission performance can be assessed mathematically. Such an analysis, presented here, leads to a numerical display evaluation index, "I", with the following properties:

- (1) "I" quantifies mission success on a ratio scale, i.e., any similar quantification can differ from "I" only by a scale factor,
- (2) "I" does not consider such impor-

<sup>2</sup>This research was supported by the Air Force Systems Command, USAF, Electronic Systems Division, under Contract AF19(628)-5176.

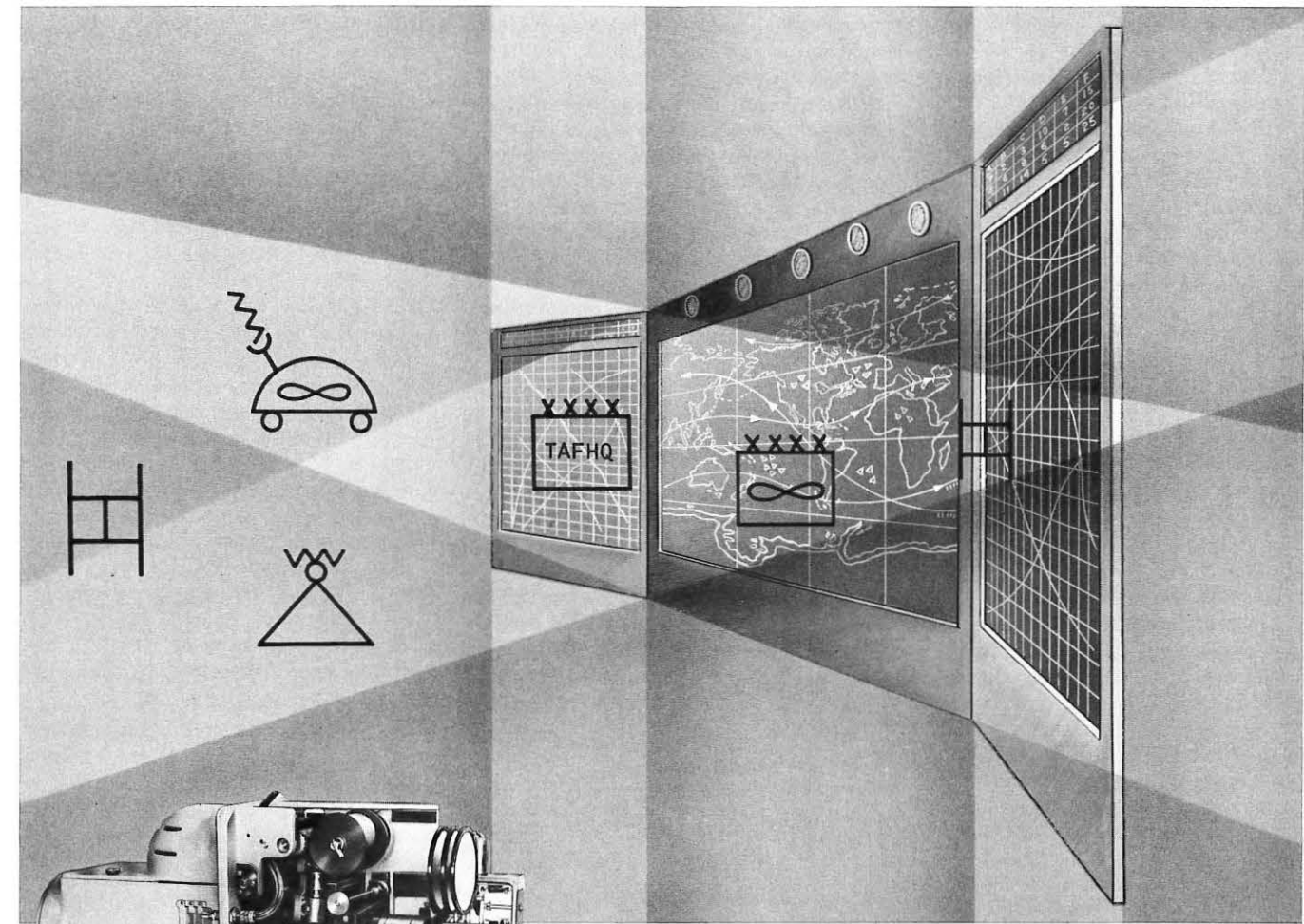

## SCOPUS II

A UNIQUE CONCEPT IN HIGH SPEED FILM PLOTTING FOR FRONT OR REAR PROJECTION

### 100 SLIDE RANDOM ACCESS CONFIGURATION

The new **SCOPUS II** Plotting Projector offers:

- Low logistics cost, simplified storage and retrieval, large storage.
- High Speed, accurate, front or rear display of dynamic track data, alphanumeric and special symbols.
- Time sharing of data.
- Acceptance of inputs from digital and analog computers and manual control units.

### THE CONCEPT:

**SCOPUS II**® plots on an opaque coated 70 mm stabilized polyester film. This new, unique plotting medium offers vastly simplified random access and extra long length films for single frame advance. The use of film simplifies storage and retrieval problems, providing a new low in the cost of logistics.

**SCOPUS II**® Plotting, Reference and Spotting projectors can be used in a wide range of display system applications in single or multiple projector units.

For an immediate technical consultation as to how our concept applies to your system requirement contact:

**Belock Instrument Corporation/Display Department**  
112-03 14th Avenue, College Point, L. I., New York 11356

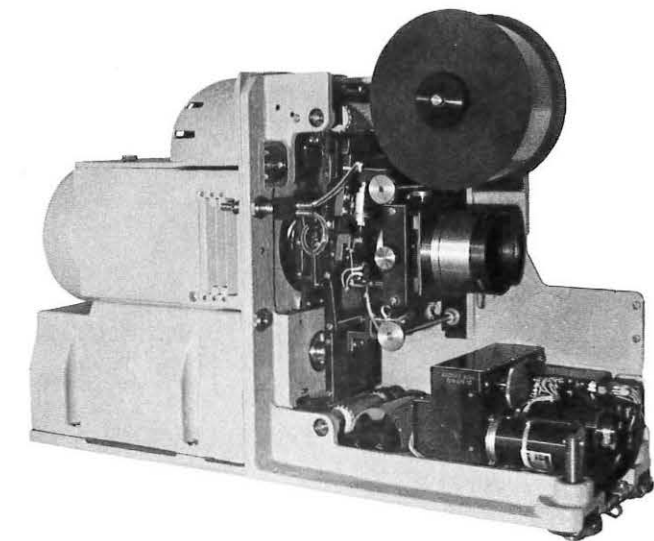

### 2000 SLIDE UNI-DIRECTIONAL CONFIGURATION

tant parameters as cost, esthetics, weight, etc., and

(3) "I" can only be approximated in any real case.

A method is derived, without posing of results, whereby an arbitrarily good approximation to "I" can be obtained. Introduction of a single plausible assumption permits great simplifications. Both the general and the simplified approaches are discussed in terms of information theory, game theory, and signal detection theory.

The limitations of this entire approach in those cases in which the system mission is ill-defined (e.g., television, movies) are discussed. Non-numeric evaluation of such displays is discussed. ●

#### Session IV

*High Resolution Multi-Color Storage Tube*, by Phillip P. Damon, Hughes Aircraft Co.

ABSTRACT: A color display storage tube having resolution and environmental ruggedness equal to monochromatic display storage tubes has been demonstrated. Color characteristics may be optimized by electronic means external to the tube with this novel design. Applications are suggested. In addition to the color-shift display, a monochromatic half-tone mode of operation in one of several colors is provided. ●

*Magneto-Optic Properties of Electroplated NiFe Films and their Characteristics as Display Elements and Devices*, by Lewis E. Somers, General Electric Co.

ABSTRACT: Electroplated NiFe films have a number of properties which, when combined properly with magnetic drive fields and colloidal suspensions of ferromagnetic particles, provide a useful display device. The optical activity of the device can be characterized by an optical grating, the period and direction of which can be adjusted both magnetically and as a material property. The properties of the magneto-optic device and the resultant display characteristics are presented.

It is possible to fabricate monochrome, color and black-and-white displays. Direct view and projection displays are possible. These have all been fabricated; their characteristics are presented. Techniques for developing grey scale and 3D displays are also presented. ●

*A New Device for Versatile Display Systems - The Electrostatic Storage Display Tube*, by Jan Engel and Arthur M. Eldridge Jr., International Business Machines Corp.

ABSTRACT: A novel approach to the storage and display of information has been recently described by the authors.<sup>3</sup> This is a technology which combines the intrinsic charge storage property of a dielectric membrane and the high speed, high resolution capability of a newly de-

veloped electron gun with an independent optical system to provide high contrast, bright, large screen display.

These ideas have now been incorporated in a new sealed tube which does not require the use of vacuum pumping equipment. This tube essentially separates the writing/recording function from the actual display function and thus provides several significant advantages over conventional storage display tubes. The write gun can be designed for high resolution at very high writing speeds. It does not need to draw a high current since no phosphor has to be lit. On the other hand, the optical display system can be independently designed to fit a number of specific applications from high density recording on film to bright, flicker free, theatre size displays. Other advantages include resolutions of the order of 2000 TV lines per useful field of view, writing speeds variable from about a frame/hour to better than commercial TV speeds, storage times of over one month (requiring no electric power), and up-date or cycle times of less than 3 seconds. ●

*PSIN-EL-PC Display*, by Richard D. Stewart, General Electric Co.

ABSTRACT: The discovery of a light-emitting negative-resistance PSIN diode (P-region-Semi-Insulating region-N region) diode has provided a new and highly successful approach toward the implementation of a solid state light emitting display.

The PSIN diode is a single crystal semiconductor device fabricated in GaAs, exhibiting a negative resistance characteristic. In the low impedance state, optical emission takes place from the face of the diode. The wavelength is 8870 Å, in the near IR.

Because of the negative resistance characteristic, these devices can be assembled into an X-Y matrix, and electrically pulsed into either an emitting or non-emitting state.

Conversion of the IR image to a visible image can be best accomplished with an EL-PC image converter.

The ability of the PSIN diode to provide a memory to the display, eliminates the need to continually refresh the display surface.

A 400 element (20 x 20) display is presently being assembled under contract DA28-043-AMC-01486(E), with the U.S. Army Electronics Command. Operation and fabrication of this display will be described. ●

*Basic EL Designs for Space and Military Applications*, by R. W. Christensen and W. R. McKeirnan, Sylvania Electric Products Inc.

ABSTRACT: A new dimension in visual displays, as well as lighting, was made possible with the advent of electroluminescence (EL). EL offers almost limitless flexibility in customized dis-

plays, as well as standard numeric and solid area displays.

By their inherent nature, EL readouts are especially suited for stringent military and space display applications. Outstanding features of these ruggedized devices include solid state reliability, hermetic seal, low power consumption, compact panel design, low reflection, wide viewing angle (almost 180°) and light weight.

This paper will present two basic EL readout panel designs: hermetically sealed, metal-glass variety and the all-glass design. They will be discussed along the lines of design, fabrication, development, "in-house" evaluations and quality testing. The all-glass design is a recent development and has a potential for larger area displays and provides optimum pin-electrode segment registry. ●

*The Cathode Ray Tube - A Child of Compromise*, (STANDBY PAPER) by D. G. Cowden and A. D. Johnson, Sylvania Electric Products.

ABSTRACT: Today's information display system design engineer is faced with the complex problem of specifying the optimum cathode ray tube to interface the system to the observer. Quite often standard "off-the-shelf" items will not meet his specific requirements and he must request a special design from the tube manufacturer.

To achieve the best possible results in the design of a cathode ray tube it is first necessary to determine the ideal tube. Then it must be decided which features are most important and which can be compromised without significantly affecting system performance.

Some of the factors discussed are size of display, deflection and focusing methods, phosphor responses and receptors, sensitivity, resolution, brightness and power requirements. Several tube designs are presented. Their most important characteristics and features are discussed from an application standpoint in contrast with those which permitted some compromise. ●

#### Session V

*The Design and Development of a Computer-Driven Electroluminescent Vertical Scale Indicator*, by J. A. Pellegrino and W. C. Vesser, Aerospace Products Research Corp.

ABSTRACT: The design and development of a digital computed drive electroluminescent (EL) vertical scale indicator under contract NAS 7-420 with the National Aeronautics and Space Administration involved the application of advanced state-of-the-art techniques to the production of a complete spacecraft quality instrument. The presentation describes the design configuration, developmental problems, and the solutions chosen for the production of the completely solid-state instrument. Emphasis was placed on

size, weight, power, reliability, and display readability consistent with conditions encountered in a spacecraft environment. Factual and detailed data presented describe digital microcircuit, EL lamp controls, and EL lamp selection and performance results. The EL lamp brightness regulated display concept utilized is described in detail. The design approach was proven by the construction and test of an instrument.

The production of the instrument is presently underway and it will be evaluated by NASA in a simulation environment. The flexibility provided by this design will allow displays color combination, observer impact evaluation and functional presentation method evaluation necessary to provide solid-state instruments that can support man's expanding effort in the exploration of space. ●

*A Multicolor Laser Digital Data Display System*, by Charles E. Baker and Larry L. Pipken, Texas Instruments Inc.

ABSTRACT: A large-screen, digital data display system which is presently being developed will be discussed. This real-time, projection display system is particularly suited for on-line operation with a digital computer. Coherent light from red, blue and green lasers is modulated and deflected to produce a 512-by-512-point, seven-color display. System specifications call for a 15-foot-lambert brightness display on a 6-foot by 6-foot rear projection screen. The design is such that the resolution can readily be increased to 1024 by 1024 points.

This laser display system differs from the previously described television type, raster scan laser displays in that all 262,144 points of a computer-generated image are stored magnetically and reproduced 60 times a second to generate a flicker-free display image. The means of scanning is such as to insure nearly perfect linearity and color registration.

The display's update rate is limited only by computer information transfer rates and can exceed one million bits per second.

The optical and electronic design of the display will be described with particular attention being given to laser selection, light modulation and deflection techniques and image storage. Photographs of actual display operation will be shown. ●

*A 200 KHz Phonevision System*, by Sid Deutsch, Polytechnic Institute of Brooklyn.

ABSTRACT: A 200 kc/sec phonevision system will be described. Since it is not possible to fully depict visual effects by means of slides, a motion picture of experimental results will also be demonstrated (if facilities are available).

The picture contains 100,000 elements. Since the given bandwidth is equivalent to 400,000 elements/sec, the frame frequency is approximately 4 cycles/sec. In order to minimize flicker with such low frame rates, pseudo-random dot scan is employed in conjunction with a medium-persistence phosphor. The system specifications are as follows:

Frame frequency 3.75 cps  
Bandwidth 196,830 cps  
Total elements 324 x 324 = 104,976  
Coarse scan 60 cps x 4860 cps  
Coarse scan elements 81 x 81  
Random scan elements 4 x 4

The bandwidth of 200 kc/sec represents a reasonable compromise between cost and quality.

As implied in the above listing, a single field consists of 81 x 81 = 6561 elements which are deposited in 1/60 second. Each of these elements is slightly displaced, during subsequent fields, in a pseudo-random fashion. During 16 fields, the entire roster of 6561 x 16 = 104,976 elements is covered.

The pseudo-random motion is provided by four square waves (30, 15, 7.5 and 3.75 cps) that can be synchronized with a single reset pulse. ●

*Evaluation of Narrow Bandwidth TV Displays*, by Dr. Lloyd Kaufman, Dr. James Lincoln, and Colin Pitblado, Spery Rand Research Center.

ABSTRACT: The design of a narrow BW TV for transmission over acoustic channels is being investigated. Among the problems associated with such a system are the identification of the properties of various scan formats which maximize the amount of usable information which can be conveyed by the system, and the determination of the limits of the observer's ability to make the kinds of discriminations which might conceivably be required with the use of such a system. The approach being followed involves performance of certain visual tasks selected to develop and sample relevant perceptual criteria. Among these tasks are discriminations of simple shape and line orientation, recognition of familiar faces, and determination of thresholds for angularity and curvature. Also under study is the possible advantage afforded by stereoscopic viewing as opposed to ordinary two-dimension presentation.

Special attention is being given to pseudo-random dot scans, dot-line interlaces, and scans which are spatially quantized, since conventional line scans at the reduced bandwidths under study result in frame rates which are unsuitable for practical use.

Basic results and technical considerations will be discussed. ●

*A Programmable Display Synthesizing System for Man-Machine Communications Research*, by Jack J. Hatfield, NASA Langley Research Center.

ABSTRACT: Much of the experimental development required in the area of flight control-display interface design can

be accomplished in the time-proven research simulator; however, present display panel implementation methods have inherent deficiencies. This paper reports on the investigation and development of a new concept for research simulator display, the purpose of which is to provide for a more effective, less costly, and less time-consuming means of creating dynamic instrument replicas. This new concept employs the synthesis of desired instrumentation at the control-display interface of the man-machine loop utilizing a programmable electronic display system.

Examples of synthesized flight displays are exhibited. System performance is discussed and compared with that of conventional computer-CRT stylized displays. The advantages of electronic animation with regard to programability, program complexity, regeneration rates, and image characteristics for certain classes of displays are presented. ●

*High Density Tape Recording of Reduced-Bandwidth TV Signals* (STANDBY PAPER), by Phillip Balaban, Polytechnic Institute of Brooklyn.

ABSTRACT: The system described here was developed in order to record the pseudo-random scan television signal developed by S. Deutsch.

The objective was to record a 61.44 KHz video signal and the associated sync signals on a ¼ inch tape running at 15 inch/sec.

The difficulties which arise in such a task are two-fold:

- Bandwidth limitations of the recorder;
- Flutter and skew of the recorder.

Since a tape recorder at this speed has a bandwidth of around 40 KHz, time division multiplexing was used to reduce the signal into two 30.72 KHz signals.

The problem is to reassemble the signals at playback. This is a difficult task since these signals are shifted in time randomly by flutter and skew. Experiments disclose that the skew is linearly distributed across the tape; therefore, by knowing the time shift at two tracks at any instant, we can predict the position of the appropriate sample at any other track.

For skew and flutter compensation purposes two reference signals are recorded on the two outer tracks of the tape.

The phaseshift of the reference signals at playback is used as a measure for the skew prediction system for each track.

Thus the video signals are sampled at the correct value. In order to reassemble the samples in the correct time sequence, they are stored in four analogue memory cells. The memory cells are read out with the aid of an oscillator which is in turn synchronized to average reference signal. The deflection waveforms are also

<sup>3</sup> J. M. Engel and A. J. Eldridge Jr., 24th Annual Conference on Electron Device Research, IEEE, Pasadena, California (June 29, 1966).

**WE GAVE**

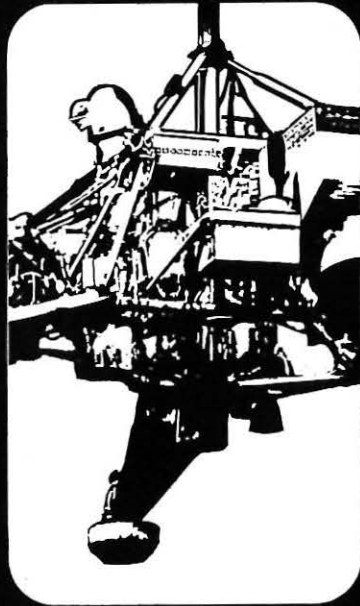

**a mirror and**



**the windows**

At Tinsley, we are proud to be counted among the illustrious company that made these tasks possible.

The amazing 11,150 pictures transmitted by Surveyor-1, were dependent upon a Brush Beryllium Substrate mirror, optically fabricated by Tinsley. . . The optically precise photographic windows for Gemini, were also produced by Tinsley. Tinsley, where engineering and electronic capabilities join over thirty years of precision optical experience.

ASTRONOMICAL TELESCOPES · COLLIMATORS  
LASER OPTICS · OPTICAL MECHANICAL SYSTEMS  
MASSIVE OPTICS TO THIRTY FEET DIAMETER

**TINSLEY**  
LABORATORIES

2248 SIXTH ST., BERKELEY, CALIFORNIA 94710  
TELEPHONE 415-843-6836/TWX 415-891-9316

62 Circle Reader Service Card No. 31

generated synchronous to this oscillator. Together with the reference signals, the frame sync signals and the audio signal are recorded.

The experimental setup uses only four tracks. Since eight tracks can be recorded on a 1/4 inch tape, a 240 KHz signal can easily be recorded, using the same techniques described above. This frequency is currently considered to be suitable for good visibility phonevision. ●

**Session VI**

*A Display Specification*, by W. C. Vesser and J. A. Pellegrino, Aerospace Products Research Corp.

**ABSTRACT:** In the process of procuring an electroluminescent (EL) display panel it was necessary to develop (1) a definition of the display requirements and terminology consistent with the manufactures terms; (2) specify the product required in measurable parameters and (3) establish the measurement techniques, instruments and procedures. ●

*Some Notes on Measuring Performance of Phosphors Used in CRT Displays*, by J. E. Bryden, Raytheon Co.

**ABSTRACT:** The technique used for measuring brightness of a cathode ray tube display has considerable bearing on the results obtained. Line and raster type measurements are compared and it is shown that there are advantages to be obtained by measuring the brightness of an isolated line with a spot photometer. However, this instrument can only be relied upon if certain precautions are taken; these are discussed. ●

Finally, a brief investigation of flicker and its relationship to refresh rate for a few screen materials has produced some interesting results. In particular, it is shown that persistence is not a good criterion for the critical frequency. ●

*Human Performance Standards in Display Specifications*, by Glenn C. Kinney, The MITRE Corp.

**ABSTRACT:** A good specification makes the procurement of display equipment both simpler and cheaper. To be a good one, a specification must clearly describe what is wanted, and this is the basis of interest in the development of standards. Since a visual display is a device to be used by a human observer, it follows that a good specification must clearly describe a device suited to human use. While other details of the display equipment may also be described, the main emphasis in such a specification is on how well the display permits the human to perform. In other words, it seems sensible to develop standards of human performance for use in specifications.

All of these combine to help direct the efforts of the display industry, both builder and buyer, toward the development of standards of display excellence based on display usefulness. Present ef-

forts on standardization must be directed toward these goals or the result may be standards for equipment, but not necessarily for displays to be used by people. ●

*Eye Movement Technique to Measure Visual Search Behavior*, by Richard J. Schiffler, RADC (EMEDI), Griffiss Air Force Base.

**ABSTRACT:** One of the missions of the Display Techniques Branch at Rome Air Development Center is to identify variables which influence visual search behavior, investigate their interactions and specify standards which should be used in designing and evaluating Large Scale Display Systems. In the information Techniques Section of the Display Techniques Branch, this research has been two-pronged. First, "in-house" and contractual efforts primarily in the area of psychophysical studies (color specifications, coding, TV resolution) and secondly, display criterion development. This latter has as its purpose the development of a metric to evaluate the information transfer potentiality of Large Scale Display designs.

In the area of Visual Search, the Information Techniques Section has recently turned its attention to the development of an eye movement device which would aid in evaluating the influences of various display parameters and be an additional diagnostic tool in the criterion development field. This paper will present the approach used in developing this device and a more detailed explanation of possible uses of the apparatus. ●

*Two-Slit Spot Measurement*, by John M. Constantine, CELCO.

**ABSTRACT:** Presents in great technical detail the theory and practice of CRT spot measurement utilizing proper slit lens combinations; evaluates variations which accrue with variations in measurement techniques and equipment; discusses precautions which must be taken in using the resolution data specified in CRT specifications for evaluation of applicability with a particular display. ●

*Capacity and Optimum Dimensions of Displays for Group Viewing (STANDBY PAPER)*, by Dr. Helmut Weiss, Aeronutronics Div., Philco Corporation.

**ABSTRACT:** Concerned with the viewing conditions in a captive audience, the author answers the questions: How much information can a display screen convey, how large an audience can it serve, and how should audience and screen be arranged for best efficiency?

These relationships are important to the systems man, who should be aware of the limited capacity of a group display (and the cost of pushing its utilization too high), to the architect who lays out the audience, and to the designer who determines the parameters of the equipment. ●

INFORMATION DISPLAY, SEPTEMBER/OCTOBER, 1966

# Would you believe a CalComp plotter and any computer can draw pictures like these in seconds?

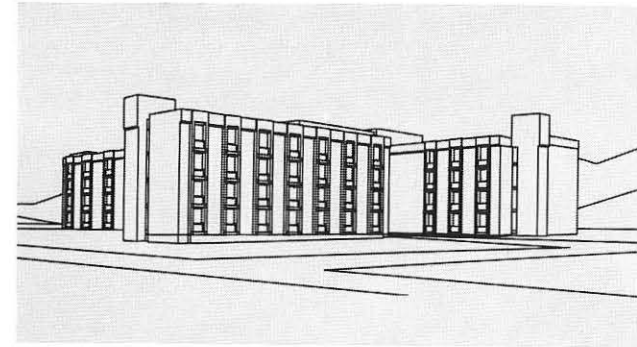

a perspective sketch of your new plant

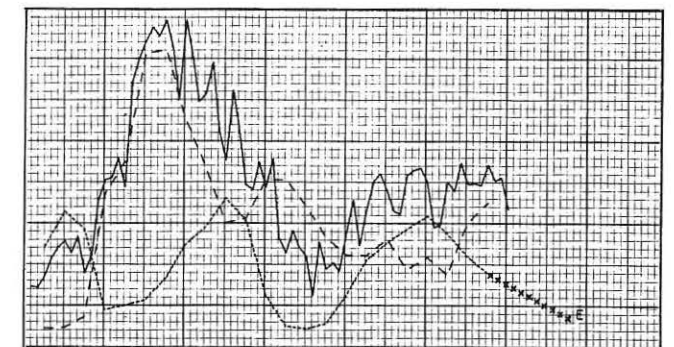

statistical trend charts

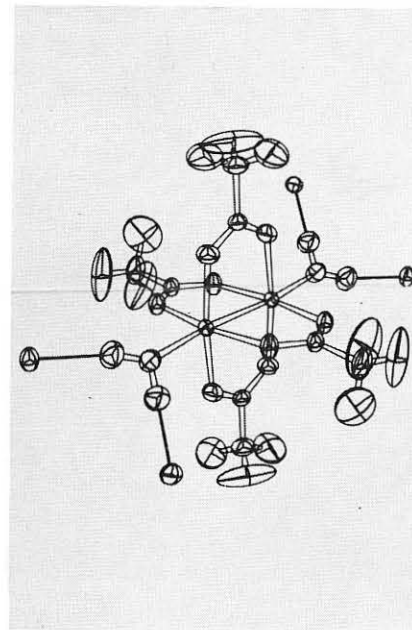

molecular, structure diagrams

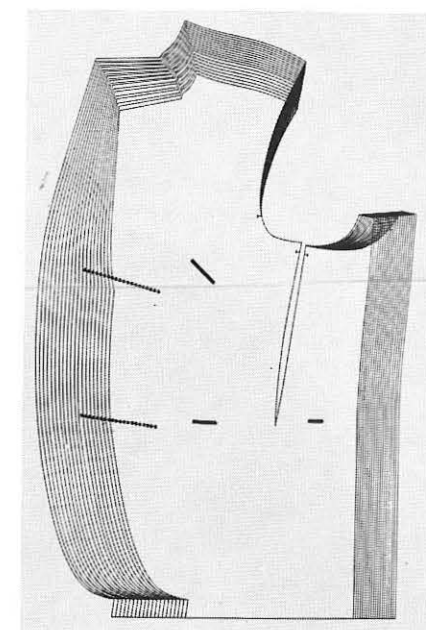

apparel patterns, graded for sizes



and even the Mona Lisa

# it can

Call or write Dept. Y10, California Computer Products, Inc., 305 Muller, Anaheim, California 92803. Phone (714) 774-9141.

**CALCOMP**

Standard of the Plotting Industry

(Talented Engineers and Programmers required—right now.)

INFORMATION DISPLAY, SEPTEMBER/OCTOBER, 1966

Circle Reader Service Card No. 32

# The Fall Joint Computer Conference

Representative Jack Brooks, of Texas, who last year authored the Brooks Bill dealing with the acquisition and use of computers in the Federal government, will address a luncheon of the 1966 Fall Joint Computer Conference Nov. 9, in San Francisco.

Brooks has indicated to R. George Glaser, general conference chairman, that he will discuss the significance of automatic data processing with the government.

The FJCC, slated Nov. 8-10 at the San Francisco Civic Center, will present nearly 50 technical sessions. The Jack Tar Hotel is conference headquarters.

Exhibits will be housed in 247 booth spaces occupying the major part of Brooks Hall in the Civic Center. According to Raymond D. Smith, SCM Corp., Oakland, Exhibits Committee Chairman, more than 100 exhibitors will participate. More than half the booth space was contracted for as early as May 1.

Contractual arrangements for exhibit space are being handled by H. G. Asmus, executive secretary, American Federation of Information Processing Societies, 211 East 43rd St., New York 10017. AFIPS is the principal sponsor of FJCC.

Exhibit layout is shown in the diagram to the right. Portraits and titles of committee officials for FJCC are presented below.

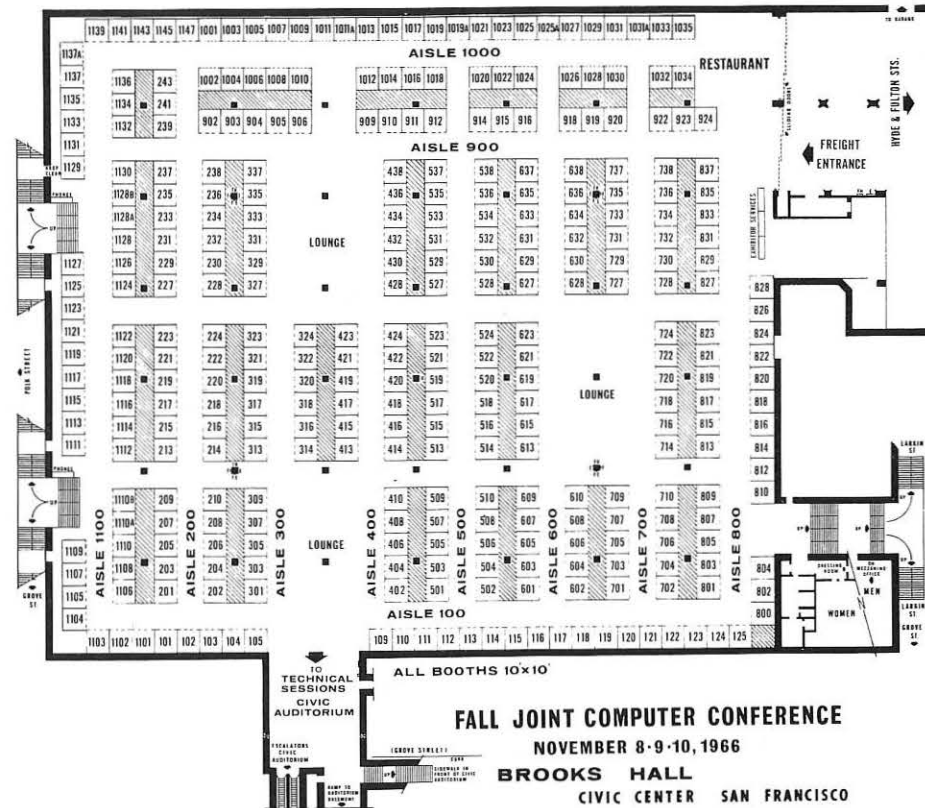

## user's choice...with the BR-90

COMBINED ELECTRONIC AND PHOTOGRAPHIC DISPLAYS... REAR-PORTED CRT... STORED PROGRAM LOGIC... These and other exclusive features combine to make the BR-90 the most versatile and flexible console available today.

Whether your computer system is used for on-line man/machine communications, off-line data manipulation, or both—you'll find the BR-90 compatible. And it can be added to your existing system with little or no change in your input/output programs or equipment.

The BR-90 lets you express your problem in your language... not the computer's. Simple, changeable keyboard overlays allow you to tailor the BR-90's display functions to suit your system's requirements, growth demands, and changes.

You tell us what your requirements and applications are... we'll show you how the BR-90 can solve your problems.

For further information contact the Bunker-Ramo sales office nearest you NOW.



Offices are located in Waltham, Mass.; Dayton, Ohio.; Rome, N. Y.; and Washington, D. C. Or write: H. A. Kirsch, The Bunker-Ramo Corporation, Defense Systems Division, 8433 Fallbrook Ave., Canoga Park, Calif. 91304. Telephone: (213) 346-6000.

 **THE BUNKER-RAMO CORPORATION**



## MINIATURE PACKAGED SCAN CONVERTERS

... New Products for Avionics ...

SUBMINIATURE SCAN CONVERTER MODULE  
INCORPORATING RW-13 TUBE

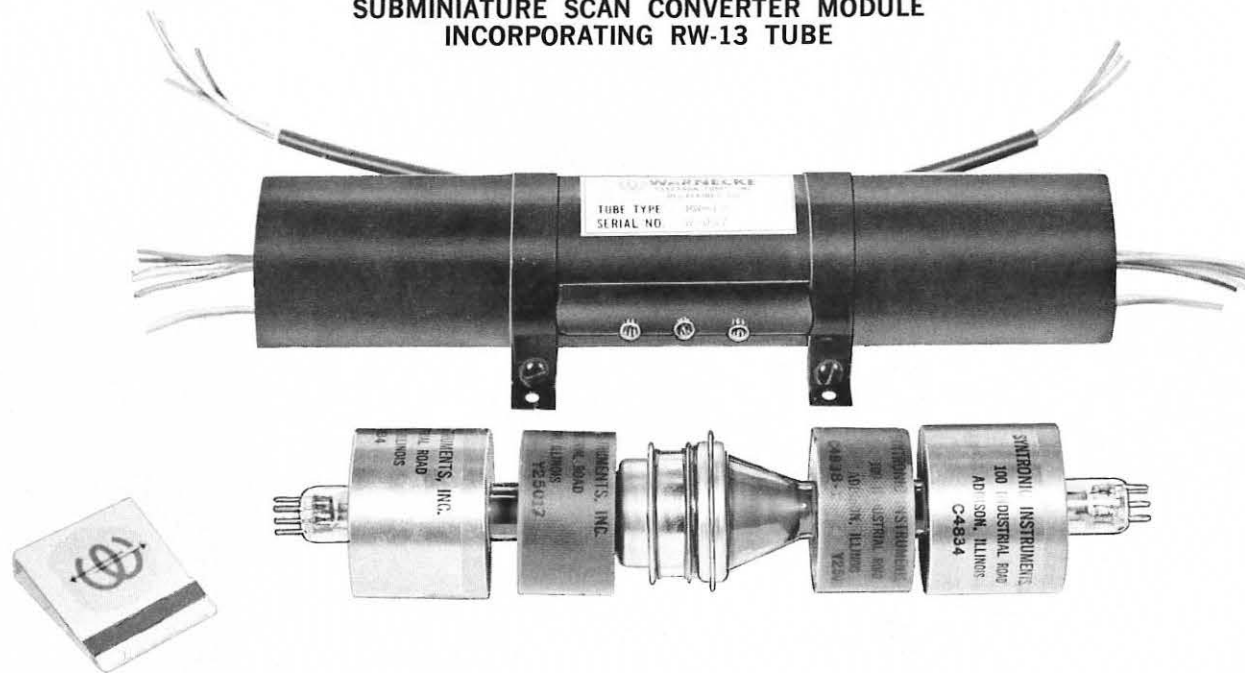

PACKAGED MINIATURE AND SUBMINIATURE SCAN CONVERTER TUBES  
FOR MULTI-SENSOR DATA STORAGE AND PROCESSING

The Warnecke RW-5EM and RW-13 are specially designed to meet the growing demands for packaged miniature and subminiature scan converter tubes. In their complementary package of shield, coils and leads, the tubes meet the requirements for the MIL-E-5400 military airborne environment.

Small size has been achieved without sacrificing resolution. The RW-5EM resolves 1200 TV lines and the RW-13 resolves 840 TV lines, at 50% relative output amplitude for orthogonal writing and reading.

The storage surface is of the EBIC type, and information can be stored indefinitely until readout. Readout time can be custom tailored from a single scan to several thousand depending upon the application.

The tubes feature a capability for quick erase of all stored information, or erasure of selected information.

Magnetic focus guns have been designed to eliminate the need for dynamic focus.

### TYPICAL PACKAGED SIZE AND WEIGHT

RW-5EM	13 $\frac{3}{8}$ " long x 3" dia.	6 lbs.
RW-13	10" long x 2" dia.	2 $\frac{3}{4}$ lbs.

 **WARNECKE**  
ELECTRON TUBES, INC.  
175 WEST OAKTON STREET, DES PLAINES, ILL. 60018  
PHONE (312) 299-4436

## ID Authors

M. D. Harsh



M. D. Harsh is Manager, Display Tube Product Development, RCA Electronic Components and Devices. He obtained his BS/EE from Drexel Institute of Technology, and did graduate work at Franklin and Marshall College. Since joining RCA in 1950, most of his work has been on design and applications of electrical-output storage tubes, display storage tubes, and special-purpose cathode ray tubes. He holds three patents and has written several technical articles. He is active on the JEDEC subcommittee preparing storage tube test methods.

Russell J. Houldin



Russell J. Houldin is responsible for IBM 2840/2250 display system development engineering. He received a Bachelor of Science in EE from Brown University in 1954, and is an active member of the IEEE. He joined IBM in 1954 and has been working on graphics-oriented projects since 1962. Prior to his current assignment

he was an engineer in tape transmission development.

Dr. H. R. Luxenberg

Dr. H. R. Luxenberg, a charter member and first president of the *Society for Information Display*, presently heads Lux Associates, Sepulveda, California, a consulting firm. His work has appeared in *Information Display* on several occasions. A complete biography may be found on page 44 of the May/June 1965 issue of *ID*, Vol. 2 No. 3.

Rudolph L. Kuehn

Rudolph L. Kuehn, who is chairman of the *Society for Information Display's* Awards Committee, has recently accepted a new position with the Night Vision Warfare Department, Electro-Optical Systems Inc., Pasadena, Calif.; he was formerly with Giannini Controls Corp. His biography appeared on page 13, Jan./Feb. 1965 *ID*, Vol. 2 No. 1.

Howard Burnaugh



Howard Burnaugh is a member of the Language Processing and Retrieval Staff in the Technology Directorate at System Develop-

ment Corp. He received a BS CheE from the University of Missouri (1956) and is continuing studies in mathematics and systems engineering at UCLA. He joined SDC as a programmer for the display area of the SAGE system. Following this assignment he has developed various interactive gaming systems and display manipulation systems. He is presently engaged in research, with Co-author Borko, on information retrieval.

Dr. Harold Borko



Dr. Harold Borko is Associate Head, Language Retrieval Staff, Technology Directorate, System Development Corporation Research and Technology Division. He is primarily engaged in research, automatic indexing and classification, and the development of automated systems for information retrieval. He was an Army psychologist until 1956, then joined Rand Corporation until SDC was formed in 1957. He received his AB from UCLA (1948), and his MA (1949) and PhD (1952) from USC. He is President-elect of the American Documentation Inst.

### AN IMPORTANT ANNOUNCEMENT ABOUT DISPLAYS . . . A REPRISE

If you saw our advertisement in past issues, you may recall that we have described CRT displays for specific computers. IDI has probably sold displays for more different computers than any other manufacturer . . . including displays for the 160A, 250, 360, 425, 440, 490, 520, 1107, 1108, 7094, DDP 24, DDP 116, DDP 224, PDP 5, PDP 8, and Spectra 70.

And we take interface responsibility.

These are "building-block" systems. Various CRT packages, function generators, and input devices can be economically combined to meet your exact requirements.

If you are concerned with computer-aided design, management information, simulation — in short, with information displays — write for data sheet 127-666. (We will send a few others also).

**At the Fall Joint Computer Conference be sure to see our Computer Control Display operating in Booth 1019.**



**INFORMATION DISPLAYS, INC.**

102 E. SANDFORD BLVD. • MOUNT VERNON, N.Y. 10550 • 914 OWens 9-5515

# AGARD-NATO Eleventh Symposium Features Display Technology



Dr. Irving J. Gabelman  
Chairman  
Eleventh Technical Symposium  
AGARD-NATO

Dr. Irving J. Gabelman, director of the Advanced Studies Group at Rome Air Development Center, Griffiss AFB, Rome, New York, is program chairman of the Eleventh Technical Symposium sponsored by the Advisory Group for Aerospace Research and Development (AGARD-NATO).

The symposium — which is devoted to “Displays for Command and Control Centers” — is being held at the Kunstlerhaus in Munich, West Germany, November 7-10.

This symposium will familiarize military and civilian NATO scientists and engineers with the present “state-of-the-art” in the field of data displays and show potential users and designers how these displays can be integrated into command and control systems.

Technical papers presented at the symposium will outline the advantages to be gained by the use of data displays, give the requirements for such display systems and point out the capabilities and limitations of the next generation of display systems.

It will also stimulate an increased awareness within NATO of the potentialities of display systems for command and control functions.

In addition to the technical sessions at the symposium, a visit to Erdfunkstelle Raising, Deutsche Bundespost (Satellite Tracking Station for Telecommunications) is planned for Wednesday afternoon, November 9th.

Attendance at this unclassified technical symposium is by invitation from AGARD national delegates or panel members. It is normally restricted to qualified persons from NATO nations whose presence will be a contribution to the symposium.

The technical program at the symposium consists of the following sessions:

Monday, November 7th 2:00 - 5:00 p.m. Military Requirements and Application Moderator: Mr. R. Lees (United Kingdom)	Wednesday, November 9th 9:00 - 12:00 a.m. Techniques I Moderator: Mr. D. Coulmy (France)
Tuesday, November 8th 9:00 - 12:00 a.m. Human Factors Moderator: Dr. G. Ulbricht (Germany)	Thursday, November 10th 9:00 - 12:00 a.m. Techniques II Moderator: Mr. E. Keonjian (USA)
Tuesday, November 8th 2:00 - 5:00 p.m. Computer Aided Displays Moderator: Mr. S. Alexander (USA)	Thursday, November 10th 2:00 - 5:00 p.m. Hardware and Components Moderator: Mr. D. Bosman (Netherlands)

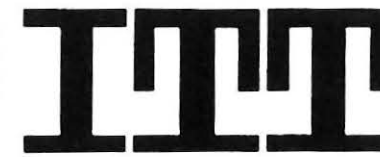

## COMPUTER DISPLAYS

State of the Art Computer Controlled Displays —  
Computer Grade Quality and Reliability — Industrial Price

### CRT DISPLAY UNITS for Graphic and Alpha-Numeric Display

#### CG 200 CHARACTER GENERATOR

For alpha-numeric display use.  
Produces character display waveforms from BCD input codes.  
Draws high quality characters, using stroke techniques with automatic corner-rounding.  
Uses plug-in character codes to facilitate changes in symbols or input codes.

Permits computer control of character intensity and size.  
Is supplied with 36 user-designated characters, expandable to 128 characters.  
Full Alpha-Numeric Character Set.  
40 microsecond average character-drawing time.

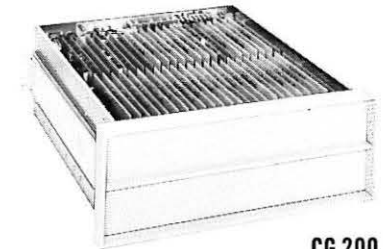

CG 200

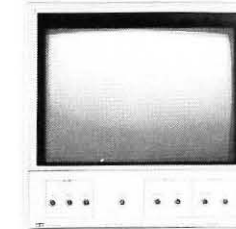

KM 906

#### KM 906 THREE-COLOR DISPLAY OSCILLOSCOPE

Model No.	CRT Size	Usable Screen Area	Resolution	Sensitivity	Video Bandwidth	Jump Scan Time
KM 906	19"	10 x 10"	15 line/cm	±5 volts for full screen	DC to 10 Mc.	25 μsec.

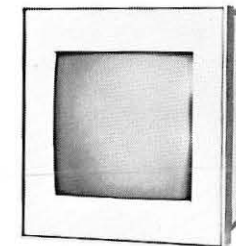

KM 105

#### KM 105 COMPUTER DISPLAY OSCILLOSCOPE

Model No.	CRT Size	Usable Screen Area	Resolution	Linearity	Sensitivity	Jump Scan Time
KM 105	21"	10 x 10"	25 line/cm	1%	±5 volts for full screen	12 μsec.

Rear-ported CRT Displays  
Hybrid Deflection CRT Displays } Available on special request.  
Special Size CRT Displays

#### DISPLAY SYSTEMS

Custom system design using standard assemblies.

Complete display system capability.

- May be assembled rapidly and economically from standard equipment.
- May include other elements, such as local memories, console keyboards, etc.
- Vary widely in application and scope. An interested and rapid response awaits your inquiry.

#### VG 201 VECTOR GENERATOR

For graphic CRT displays.  
Draws straight line vectors of any length.  
Uses absolute coordinate input data. Normally mounts in the DD-101 Interface Unit.  
Full screen vectors.  
Automatic intensity compensation for writing beam speed.  
100 microsecond vector time.

#### LP 303 LIGHT PEN AND AMPLIFIER

For operator use with CRT-displayed data.  
Provides computer identification of specific symbols or character.  
Uses flexible fiber-optics cable.

#### DD101 DISPLAY CONTROLLER

Computer control of switching between character, vectors and points.  
Interfaces available with most computers.  
For computer-display linkage.  
Converts binary inputs to precision analog positioning voltages and internal control signals.  
Interacts with the computer on a request-response basis.  
Accepts any polarity computer input signals.  
Operates directly from 36-bit or 48-bit input-output data channels.  
May be supplied with an assembly register for use with narrow I/O channels.



INDUSTRIAL PRODUCTS DIVISION • 15191 BLEDSOE STREET • SAN FERNANDO, CALIFORNIA 91342 • PHONE EMpire 7-6161

A versatile film reading system with electronic readout and . . .

# 10 MICRON ACCURACY

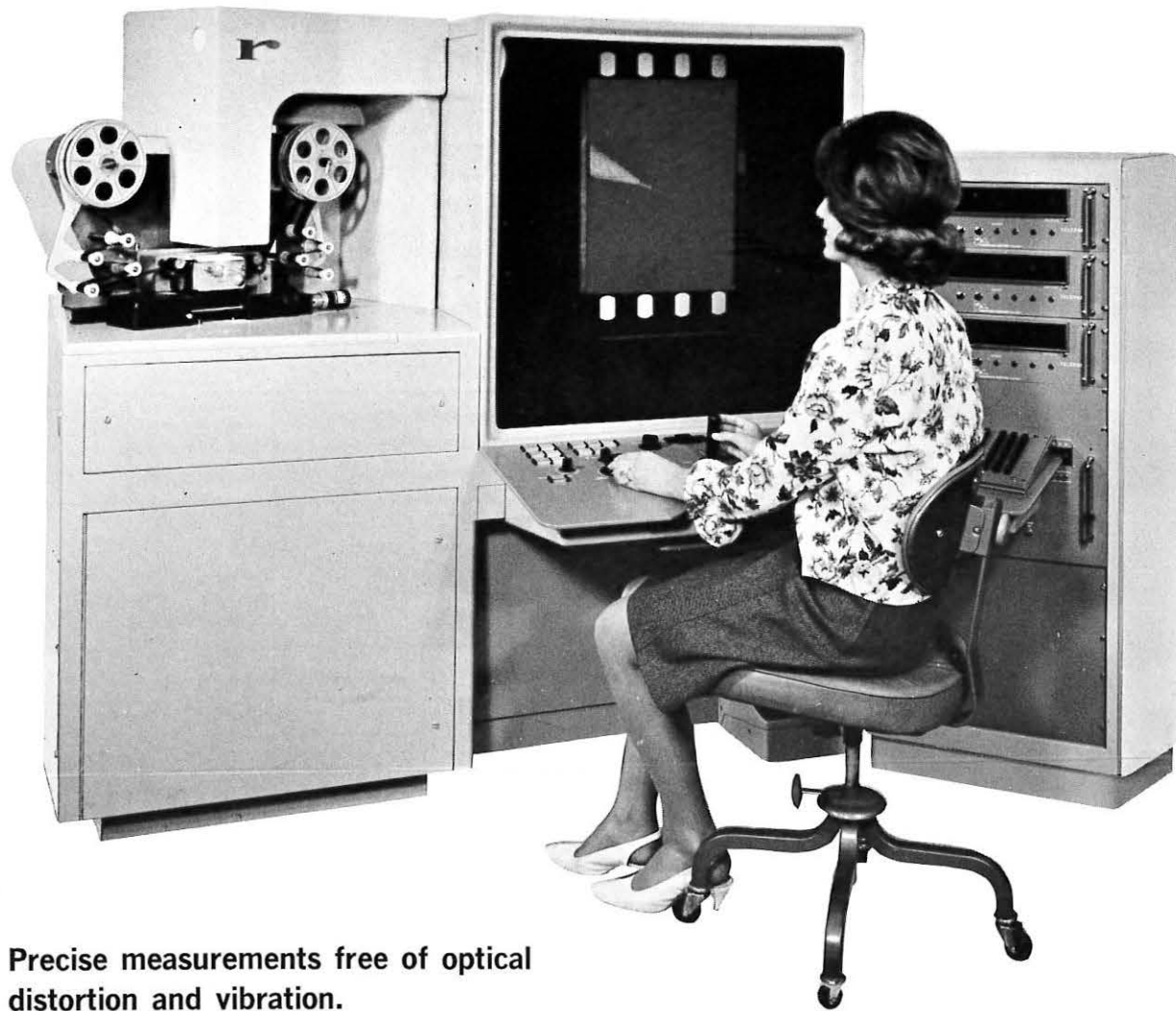

Precise measurements free of optical distortion and vibration.

## Richardson Model R-660 Film Reader

This is our finest system for semi-automatic recordings of X, Y, and O coordinates of projected film images. A **unique** measurement system provides laboratory tolerances and high speed efficiency for repeatable accuracy of less than 10 microns. Model R-660 features electronic readout of data into punched cards, tape, or typewriter records. Interchangeable film transports designed for 16mm, 35mm and 70mm film sizes make this a most versatile system.

We invite your inquiries on this and other Richardson designed film systems.

**Also Available** — New catalog of precision Film Transports for all film sizes.

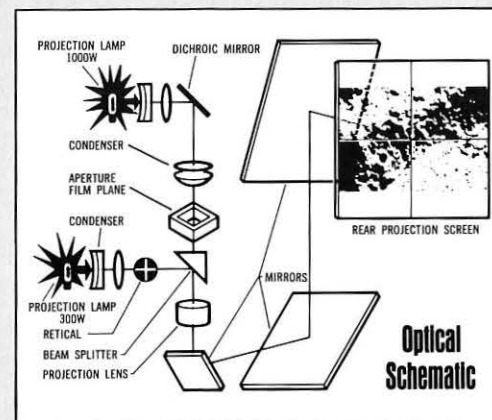

Richardson Camera Company P.O. BOX 9187 ■ PHOENIX, ARIZONA 85020 ■ PHONE 602/944-2671

## ID Readout

### Flexible Aperture Display

Electro Tec Corp., Ormond Beach, Fla., has just begun intensive development of a "Flexible Aperture Display" (termed FAD). Several engineering models have been constructed and, according to George K. Pandapas, the firm's president, it can be actuated by a variety of means, electro-mechanical, mechanical, pneumatic, etc. He told *ID* the firm is presently evaluating prospects in various development areas. According to Stanley Stephenson, ETC director of research, the device lends itself nicely to use with a 35-element alphanumeric display, or equally well to a 7-bar over 14-bar segmented readout: "As such, it has numerous potential applications, including brokerage boards, airline terminal displays, as a sequential counter, or in non-sequential readouts. It utilizes a flexible membrane, to which a button-type or bar-type plunger projects. It can utilize any color up to and including translucent, for backlighting." One advantage cited: The higher the ambient light, the greater the contrast and visibility. Plungers can be translucent, for backlighting, or can be impregnated with a buffer to provide a glow. Although ETC is primarily known for slip rings and relays, the firm in recent years has engaged in major research in advanced information display techniques. Other areas of ID interest, aside from FAD, include a two-axis solid-state scanner (licensed to Monsanto), and a single-axis solid-state scanner (in-house R&D).

### Fluid Digital Memory Holds With Power-Off



A display-oriented advance in fluidics technology was registered when the NASA Electronics Research Center, Cambridge, Mass., accepted delivery of a read-write fluidic memory which holds its stored data through any number of power shutoff cycles, without the use of moving mechanical parts. Developed by the Astromechanics Research Division of Giannini Controls Corp., Duarte, Calif., the unit incorporates an alphanumeric display and punched-card reader. (Both of these peripherals are also pure fluidic devices developed by Giannini.) Basic to the accomplishment is a fluidic technique described by the company as proprietary. Designed to demonstrate the feasibility of a non-volatile, non-destructive-readout fluidic data storage, the memory has a three-bit capacity. Any one of eight letters of the alphabet is entered by inserting a conventional punched card into the reader. The three-bit code corresponding to the letter is thus entered into the memory — where it will reportedly remain indefinitely, regardless of how often it is read out, or how often power is removed. Only reading in a new letter will alter the contents of the memory.

## Lighted Pushbutton Switches



### USECO offers greatest capacities, smallest sizes.

USECO'S ORCON switches combine exclusive multi-circuit capacity, isolated contacts, sliding-wiping action, independent light circuit and connector convenience in 3/4" and 11/16" diameter sizes. Standard and custom available. Plus indicator lights, ganged assemblies, multi-light units, adapters and accessories. For brochure, contact USECO, 13536 Saticoy Street, Van Nuys, Calif. 91409. (213) 873-3520.



Division of Litton Industries



# You can't beat the Tung-Sol Digital Readout for brilliance



Average brilliance of 1000 foot-lamberts of clear, white light at only 4 volts makes the Tung-Sol DT1511 the brightest display available. The high contrast between illuminated characters and the flat, dull viewing panel provides utmost visibility under every condition of ambient light. Excellent standards of performance can be achieved with as little as 2.5 volts.

Visors, hoods, or other light shades are unnecessary. The seven-segment characters are surface-flush and require no supplementary optics. There is never any "crosstalk" and no stray reflections.

For all the facts, including physical and electrical specifications, write for Bulletin T-431. Tung-Sol Electric Inc., Newark, N. J. 07104.

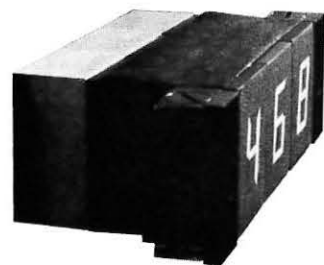

Optical design of the characters and high surface illumination permit extreme-angle viewing. (Photo at 150° angle)

All viewing surfaces in the illustrations are unretouched.

**TUNG-SOL®**  
**HI-OPTICS**  
**DIGITAL DISPLAYS**  
The most thoroughly engineered  
readout on the market.

Whenever power is on, the binary number stored in the memory is available as a trio of air-signals. The air-pressure signals are said to be compatible with Giannini Controls' own fluid logic devices and with most other digital fluidic elements—such as the Harry Diamond Laboratory designs. The fluidic display uses reflected light behind a rectangular matrix of small round dot-like apertures. By means of the same fluidic technique, the input signals "unblank" the appropriate dots so that they pass light to the viewer, forming the required alphanumeric character. This approach allegedly lends itself to displays of any desired size, brightness, or complexity. In the next phase of its research program, Giannini will work on analog fluidic computing elements, particularly an infinite-input-impedance amplifier. The company contends all existing analog fluidic amplifiers act as heavy loads on their signal sources, leading to distortion of the source signals, severe limitations on "fan-out" (the number of amplifiers which can operate from one signal source), and large steady-state and dynamic errors.

Giannini expects to deliver an amplifier to NASA this year which will respond to and amplify input signals in the form of pneumatic pressure (steady-state or dynamic), but which will require no steady-state mass flow whatever from the signal source. However the amplifier presumably will be capable of supplying output power (in the form of mass flow) or a zero-flow pressure signal.

#### "Blackboard-by-Wire" Teaching System



General Telephone and Electronics Corp. has announced development of an electronic teaching system that transmits voice communications and handwriting over telephone lines for long distance illustrated lectures. A spokesman said the new integrated system provides high-quality visual display handwriting, diagrams, formulas, equations, and other graphics on a TV monitor within a classroom, thereby supplying an important, convenient, economical educational sup-

INFORMATION DISPLAY, SEPTEMBER/OCTOBER, 1966

plement. In addition to the TV monitor and loudspeaker at each classroom reception point, the system includes an equipment unit and a question-indicator panel and microphone which allow students to ask questions and discuss ideas with the instructor. A light-indicator panel on the instructor's desk-type transmitting console signals him when a student wishes to interject a question or comment. Provision is made for use of light pen by the instructor.

#### Securities Quotation Displays

Two new brokerage quotation facilities have been described in detail by the manufacturers in the increasing trend toward full automation of quotations and their display.

The first, by Ultronic Systems Corp., New York City, is a visual display system for real-time reporting of trading on the stock exchanges. Operating electro-mechanically, the system presents characters reporting each transaction on an endless belt moving from right to left. Thousands of small discs on the belt, each having a white and dark face, are positioned by compressed air to form letters and numerals.

The second is the development of a smaller version of the electronically controlled 45-ft. securities quotation display at the New York Stock Exchange by Recognition Equipment Inc., Dallas, Tex., for Trans-Lux Corp. for utilization in brokerage firms. Thousands of small discs are mounted on an endless belt which moves right to left across the display. Bright green 2-in. characters, formed as jets of air flip the discs, will move across a black background at speeds up to 900 characters a minute. The units are capable of displaying a variety of information such as weather data, management information, and status reports.

#### LDX-EDP Advances Railway Operations

A Xerox LDX facsimile system and electronic data processing has been installed in the Southern Railway System (headquarters are in Atlanta, Ga.) to increase car distribution efficiency and report car locations accurately. As a freight train enters the Southern system, a way-bill which identifies the car and its cargo is inserted into the LDX scanner. A facsimile is instantaneously made at the Atlanta Center by an LDX printer. When all of one train's waybills are in, the data are transcribed to punched paper tapes. The computer can report, on immediate demand, the exact location of each train, car and cargo in the system. It can also give an instant breakdown of car distribution, car utilization, commodities being transported, and total billing.

#### TV Camera/Cytoscope Aids Med Students

A TV camera connected to a cytoscope and utilizing a special fiberoptic illuminating system may soon enable an entire class of medical students to look together inside a functioning organ. Research to develop the device was announced by Dr. John K. Lattimer, chairman of the Dept. of Urology at Columbia University College of Physicians and Surgeons, New York City. A grant of \$128,000, from the Commonwealth Fund, supports the research. The device would be made possible by the binding together of approx. 200,000 fiberoptic rods. A light source at one end would throw a cold light of great intensity through the rods into the patient's bladder. A TV camera attached to the cytoscope would transmit the picture to television screens so that students could follow the surgeon's procedures. Color photographs and motion pictures have already been made with this system as an aid in teaching.

#### Computer in Digital Mapping System

A system for automatically drawing maps from aerial photos for the Army is being developed by the Itek Corp., Lexington, Mass., under a contract from the Army's Geodesy, Intelligence and Mapping Research and Development Agency (GIMRADA). A Model 3100 computer, by Control Data Corp., Minneapolis, Minn., will be utilized by Itek to control

INFORMATION DISPLAY, SEPTEMBER/OCTOBER, 1966

## We can solve your MAGNETIC SHIELDING PROBLEMS

with  
**\*MAGNALOY**  
a mu-metal material



**\*MAGNALOY . . . a Nickel-Iron alloy** of extra-high permeability, designed to give the ultimate in shielding attenuation—Hydrogen annealed for maximum permeability—guaranteed by our Seal of Certification.

ALSO AVAILABLE . . . our "MAGNALOY" Foil . . . an .004 light gauge mu-metal material for special shielding applications.

### AS SPECIALISTS IN THE FIELD of Magnetic Shielding Components . . .

We are qualified—technically and thru extensive experience—to serve you from an engineering and consultative basis, and to assist you in the design of components to meet your specific Magnetic Shielding requirements at highly competitive prices.

### ON YOUR STAFF BUT NOT ON YOUR PAYROLL

- Quotations submitted on request, per your Blue Print, for Engineering Samples—Prototypes—Production Runs
- Engineering design assistance and consultation
- Precision fabrication to your exact engineering specifications
- Hydrogen annealing with "Certification" on all fabrication
- Production delivery geared to your scheduled requirements.



*Magnetic*  
**Radiation Laboratories, Inc.**

7325 West North Avenue • River Forest, Ill.  
Phone 771-7172 • Area Code 312

Circle Reader Service Card No. 40

**EL**

Mr. Alfred MacIntyre, with many years experience in the field, has joined Video Color as manager of the Electroluminescence Dept. to develop and supply special purpose display panels and devices.

**SAMUEL F. CARLISLE**  
Chief Engineer

**MEIER SADOWSKY**  
Vice President

## Here's what Video Color offers:

### TECHNICAL ABILITY

For any special purpose Cathode Ray Tubes  
**THIN TUBES**

Monochrome and Two Color Flat Tubes

### ULTRAHIGH RESOLUTION

(Less than .0005" spot size)

### FIBER OPTIC FACES

### HIGH CONTRAST

Special Ultrathin glass substrates to eliminate halation  
Projection Tubes—Ultra High Light Output

### SPECIAL SCREENS

Any Phosphor  
High uniformity, Ultra Smooth Texture  
Low Screen Noise  
High Light Output

### SPECIAL ELECTRON OPTICS

High Deflection Sensitivity  
High Beam Currents  
Multiguns  
High Voltages

### SPECIAL GEOMETRICS

Back Ported Tubes  
Special Deflection Angels

### SPECIAL GLASS STRUCTURES

Internal Targets

### FULL LINE OF STANDARD TYPES CRT's FOR —

Character Generators (Monoscopes, etc.)  
Readouts, Printers, Oscilloscopes, Radar,  
Monitors, Video Recorders, View Finders,  
Flying Spot Scanners, Back Ported Devices,  
Computers, etc.

## Video Color Corporation

500 S. Douglas St., El Segundo, California  
Phone: 213 - 772-5251 90245

operation of electromechanical scanning and printing units (used to scan high-resolution stereo photographs), and to produce the finished maps and corrected photographs. Along with correcting various types of distortion, the computer will process photo information to detect slight differences in stereo photos that indicate ground relief or elevation.

### Tactical Video Mapping

A system for rapid, accurate recording and display of vital airspace control information in a tactical situation has been developed by the Surface Div., Westinghouse Defense and Space Center, Baltimore, Md. Called TAC-MAP (Tactical video MAPping), the system is compatible with tactical radar Plan Position Indicators (PPI's). Developed for tactical air control system elements operating in the field, the system can also be utilized without modification for other types of radar control centers such as ship and shore naval, and military and space command. TAC-MAP utilizes a slow-scan vidicon camera synchronized to a radar trigger pulse, and produces a video map or other information for display on associated PPI's. Maps are produced by hand-tracing of geographic features, coordinates, and other information from operational maps onto a translucent or transparent overlay. The overlay is immediately scanned by the camera, producing an accurately-scaled image on connected PPI's. Expansion and off-centering of the PPI images can be selected as desired. Original position accuracy, as traced directly from an operational map, is maintained. Mapping information in a tactical situation which may be plotted includes permanent information, such as principal geographic features, natural boundaries, fixed navigational aids and airfields; and, dynamic information, such as plotted coordinates of a specific target, location of a forward air controller, drop zone, temporary or mobile navigational aid, turning or initial point, the outline of free strike areas, gun-defended positions or flak corridors.

### Man-to-Man Graphic Communications

Introduction of a new, compact, facsimile communication system — the Alden 4 Dispatch — is scheduled for the fall of 1966 according to the manufacturer, Alden Electronic & Impulse Recording Equipment Co., Westboro, Mass. It is of modular construction and modern design, will be housed in a compact, roll-around console unit that can be quickly moved to various operating positions for ease of use. The console will provide facsimile transmission and automatic, unattended reception of graphic information for both in-house and long-distance communications using ordinary telephone lines. It can include push-button internal voice facsimile switching, Data-Phone subset, voice communications, and dictating equipment. The Data-Phone subset can provide automatic switch-over so that the recorder will operate as an unattended slave to the scanner signal. The Alden 4 presents a change of emphasis for Alden Electronic which, in the past, has produced systems for broader commercial uses. It is described as a "person-to-person" system, and is for office use. Handwritten or typewritten memos, newspaper clippings, and patent abstracts are a few examples of the graphics it will transmit and receive over national telephone circuits with high fidelity, according to Alden.

### India Establishes \$7 Million Computer Net

The government of India has announced plans to establish a nationwide computer network beginning later this year. An agreement signed in Washington by Indian Ambassador B. K. Nehru and James H. Binger, chairman of Honeywell Inc., covers ten computers, valued in excess of \$7 million, that will form the first stage of the new government information system. Honeywell will provide the computers. "The system will tangibly improve India's economic and administrative posture," said K. S. Sundararajan, minister of eco-

nomics at the Indian embassy in Washington. He described it as one of the first attempts by an Asian government "to organize, correlate and make use of vital data by automated means."

Initially the computers will be used for water and power network analyses, income tax processing, labor statistics, licensing and import-export control. Four units will be installed later this year in the New Delhi offices of the Central Water and Power Commission, Central Board of Revenue, Ministry of Labor, and at the office of the Directorate General of Technical Development (DGTD), Ministry of Finance. Additional systems will go into operation in 1967 in New Delhi, Bombay, Calcutta and Madras, to support the government's expanding computational needs, and to provide computing services for other government departments not initially included in the information network.

Installation of the computers "constitutes the first phase of a long-term program to bring India's government modern tools to match its modern administrative goals," Mr. Binger stated. He said additional equipment will be added as the program expands. The first ten computers are being supplied by Honeywell under a special arrangement with the Indian government. The computers are medium-size Honeywell 400 systems of a type used by numerous organizations in this country and abroad. C. W. Spangle, vice president and general manager of the firm's electronic data processing division, said the agreement "provides us with an opportunity to enter a potentially significant market for our products, at the same time it provides India with the means to develop its own ambitious programs at a favorable cost." Honeywell will provide supplies, spare parts and technical training in addition to the computer equipment, and will establish a support organization in India in the next several months "to assist in implementation of the program and to evaluate future potential markets for our EDP equipment in that area of the world."

### Air Force Shops for 100 to 160 Computers

Letters of interest from vendors of commercially available electronic data processing (EDP) computer systems are being sought by Electronic Systems Division of Air Force Systems Command. Between 100 and 160 new EDP systems will be acquired to replace and update EDP equipment in the Base Level Data automation Standardization Program throughout the Air Force in the civil engineering and accounting and finance areas. The exact number of new systems will depend on the size and cost of configurations. Up to four configurations of a basic computer system may be proposed. They will contain high-speed central processing, immediate access storage, magnetic tape and punched card input/output devices. Address inquiries to Electronic Systems Div., Hanscom Field, Mass. (617) 274-6100, Ext. 5322.

### Photographic Recorder Utilizes Laser Beams

Autonetics Div. of North American Aviation has announced development of a new photographic recorder which utilizes a laser beam to generate images. Recently delivered to the Air Force for additional evaluation, the laser light recorder could be utilized for high-quality, high-speed picture transmission similar to present-day facsimile transmission of news photos or pictorial information from radar or TV recon sources. A helium-neon laser, focused to a spot 0.0004 in. diam., is employed to sensitize a fine-grained, high-resolution photographic film. The closely-spaced lines form an image much the same as that on a TV CRT. Only one ten-thousandth of a watt of light power is needed for operation. According to Autonetics' Dr. I. H. Swift, Director, Electro-Optical Laboratory, Torrance, Calif., the device is capable of recording all the image detail of a normal TV picture on 0.1 sq. in. of photographic film.

## INTRODUCING: THE LARGE SCREEN, HIGH RESOLUTION L-4192

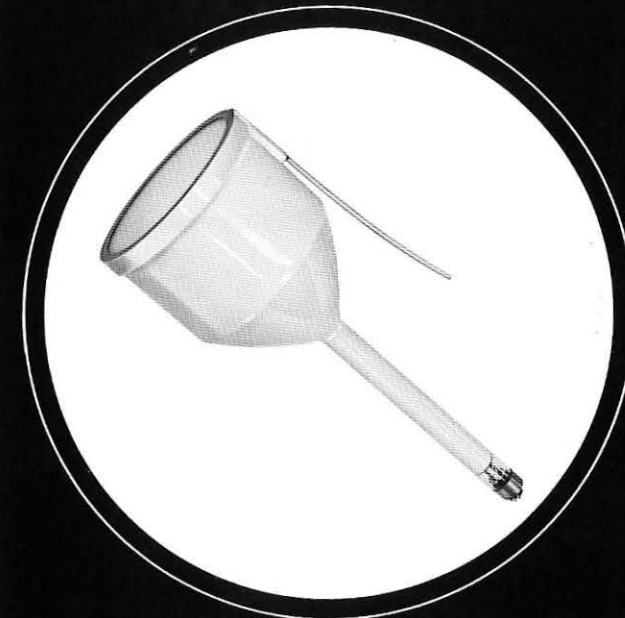

## FOR LOW NOISE FLYING SPOT SCANNING

The L-4192 has been designed for high resolution flying spot scanning applications where it is desired to reduce phosphor loading and effective phosphor noise while retaining high light output. The tube employs a 9", 40° envelope, 26" long and is electromagnetically focused and deflected. Spot size is 33 microns. The faceplate is flat with a useful phosphor screen diameter of 8 3/8". The highest known phosphor screen quality in the industry is produced by a special Litton phosphor deposition technique. The more widely used phosphors are available, such as P16, P24 and P11, among others.

Use of this large diameter CRT in scanning or recording systems permits greater optical reduction, thus decreasing phosphor loading for a given resolution at the film plane. This allows realization of higher light output with a resultant improvement in scanning system signal-to-noise ratio.

Tube mounts and electronic equipment are available for this tube as well as for other CRT's.

For information on this equipment and the complete line of display devices, write San Carlos, California or call (415) Lytel 1-8411.

**LITTON INDUSTRIES**  
**ELECTRON TUBE DIVISION**

San Carlos, California / Canada: 25 Cityview Drive,  
Rexdale, Ontario / Europe: Box 110, Zurich 50, Switzerland

**Celco**

# TWO-SLIT SPOT ANALYZER

FOR DETERMINATION OF CRT SPOT CHARACTERISTICS

With the CELCO Two-Slit CRT Spot Analyzer  
—a scientifically designed and fully calibrated instrument—  
high standards of resolution may now be specified.

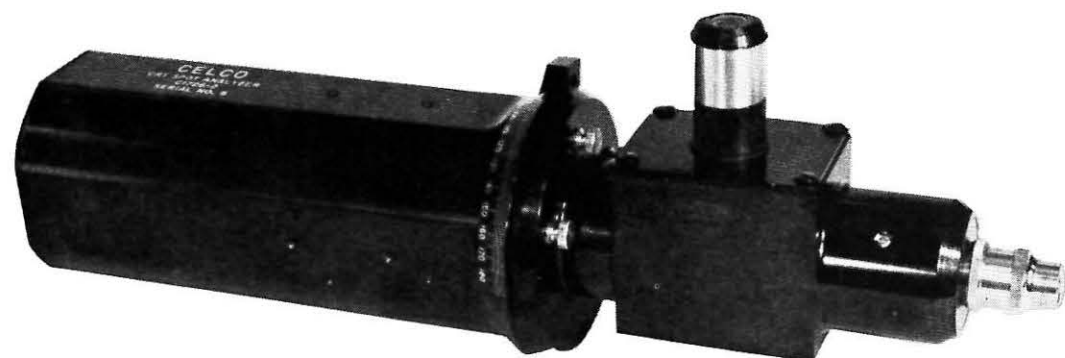

HALF AMPLITUDE SPOT DIAMETER

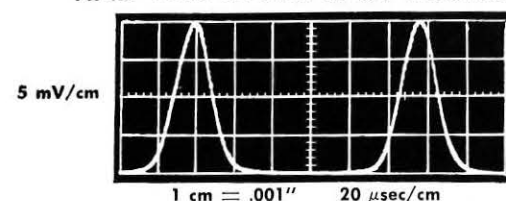

PHOSPHOR RISE and DECAY TIME

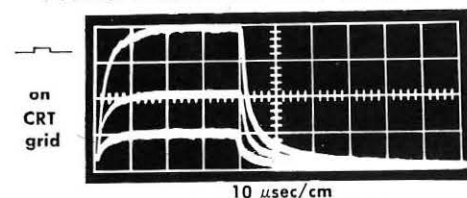

CONTRAST RATIO BAR CHART

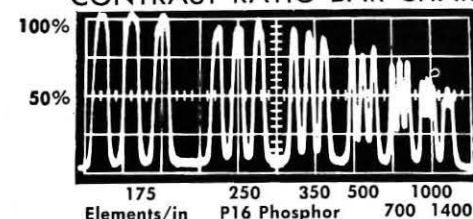

P11 PHOSPHOR or FACE NOISE

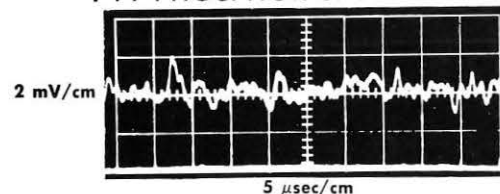

DOUBLE LINE METHOD

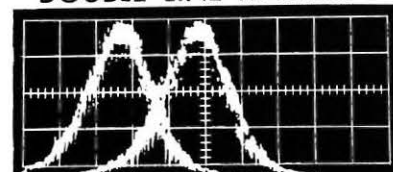

(2 line raster parallel to single slit)  
3 sweep signals needed, raster must be moved vertically. Measurement of line spacing must be made on CRT face

TWO-SLIT METHOD

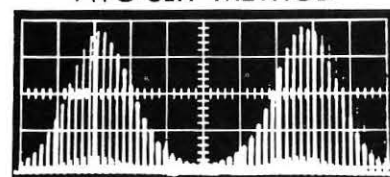

(Single line raster parallel to slit pair)  
Only 2 sweep signals required.  
Distance calibration is locked into analyzer. No measurement on CRT face

## on the move

Richard A. Roderick has been named southwestern regional numerical control mgr. for Bunker-Ramo Corp., Cleveland, O., and will continue to have offices in Braniff Tower, Dallas, Texas.

Dr. Milton E. Mohr, pres. of The Bunker-Ramo Corp., will serve as pres. and chmn. of the board of the firm's newly-created subsidiary, B-R Data Systems Inc. which will be based at the parent firm's Silver Spring, Mr., facility. Other officers are: O. R. Lodge, VP and gen'l mgr; Willard D. Murphy, VP/Finance; and Samuel B. Sterrett, sect'y.

James P. Whitfield has been named mgr., mktg. admin., a new post at Data Products Div. of Stromberg-Carlson Corp.

Amperex Electronic Corp., Hicksville, L.I., N.Y., has promoted Hank Steenbeke to Western regional sales mgr. and Arthur F. Kelly Jr. to ass't renewal sales mgr.

John L. Moser has been appointed dir. of systems engrg. and Harvey Cohen has been named mgr. of advanced programs for Scientific Data Systems, Los Angeles.

Switchcraft Inc., Chicago, has announced the promotions of Clyde J. Schultz to the newly-created position of industrial sales mgr., and Anthony F. (Hank) Anderson to the post of distributor sales mgr., succeeding Tom Dowell. Dowell will head his own electronic manufacturers rep organization handling

both distributor and OEM accounts in Kansas, Missouri, Iowa and Nebraska, with the main office being located in the Greater Kansas City area.

Donald E. Young has been elected VP/Corporate Communications by the Board of Directors of Burroughs Corp., Detroit, Mich. In his new post, Young will have the responsibility of developing and directing the firm's internal and external communications with employees and the public.

Walter Hanstein Jr., formerly with Burroughs Corp., has joined Automation Engineering Laboratory Inc., Stamford, Conn., as VP. Hanstein will be in charge of technical implementation for AEL Development and Research Inc. and AEL Food Automation Inc.

George J. Vosatka has been elected to the post of VP/Mktg. and E. E. Landefeld has been appointed dir. of administration for Informatics Inc., Sherman Oaks, Calif., it was announced by Walter F. Bauer, pres.

Robert F. Anderson has been promoted to the newly-created post of dir. of industry mktg., and Jerome Tagg has been named to the new post of mgr. of information technology, mktg. education dept., of Honeywell Inc.'s electronic data processing division.

John V. Sigford has been named operations mgr. for Setchell Carlson, Minneapolis, Minn., newly-acquired sub-

sidary of Marquette Corp.

Richard H. Baker has joined Management and Economics Research Inc., Palo Alto, Calif., as director of electronic industry research. Baker was formerly with Stanford Research Institute, and Digital Control Systems, San Diego, Calif.

TRW Systems, Redondo Beach, Calif., has appointed Edwin A. Goldberg to the position of manager for its newly-formed Guidance System Development Department, Guidance and Navigation Laboratory, Electronic Systems Division. The department Goldberg heads is responsible for the design and development of guidance and navigation systems including gyrocompasses, inertial attitude references, and strapdown guidance systems.

### CORRECTION

Because of a typographical error in which a type line was transposed, an item appearing in this column in the July/August issue of **Information Display**, announcing appointment of **William J. Burros** as Controller for Dialight Corp., indicated that the firm is located in Silver Spring, Md., which is not the case. Dialight is located at 60 Stewart Avenue, Brooklyn, N.Y. 11237. **Information Display** regrets the error.

## fassst!

± 40 VOLT ALL SILICON  
DEFLECTION DRIVERS



RDA-PP6N-1R

12 Amp Change in  
Less than 9 μ sec  
With 25 μH Yoke

0.02% Linearity

- Direct Conversion E in to I out
- dc to Pulses and Complex Waveforms
- Compatible with Single-ended Yokes
- No Synthesizing Networks Required
- Needs only 115 Vac
- Minimum Crosstalk

YOKES  
**Celco**

Circle Reader Service Card No. 44

Constantine Engineering Laboratories Company  
Mahwah, N. J. Upland, Cal.

**NEW**  
**RASTER GENERATOR**  
DUAL SWEEPS

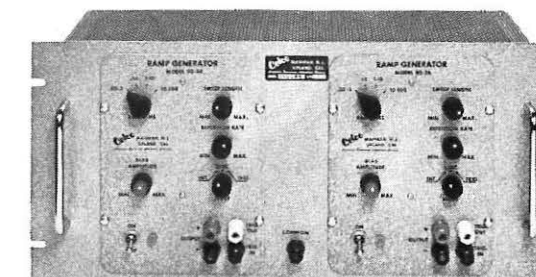

2 SG-2BR

- All Solid State
- Linearity Better than .5%
- 10% to 90% Duty Cycle
- Sweeps from 20 μsec to 100 msec
- External Trigger or Sync

YOKES  
**Celco**

Circle Reader Service Card No. 45

Constantine Engineering Laboratories Company  
Mahwah, N. J. Upland, Cal.

**Celco**

Constantine Engineering Laboratories Company

MAHWAH, N. J.  
201-327-1123  
TWX 201-327-1435

UPLAND, CAL.  
714-982-0215  
TWX 714-556-9550

## Book Reviews

**The Computer Display Review.** A subscription service of Adams Associates, Cambridge, Mass.

*The Computer Display Review* is intended as an information source for those individuals associated with computer-driven graphic displays of any type. The loose-leaf volume making up *The Review*, is not a book in the normal sense of the word and hence is difficult to review against the usual criterion. It is, rather, a compendium of results of an extensive study conducted by Adams Associates, and could be looked upon as a sort of De Luxe Display Survey for those primarily interested in computer graphics.

The organization of *The Review* is excellent and comprehensively traces the development of the computer-driven display art to the present day. The tutorial treatment of Software Techniques is especially complete and I believe this is the first time such a total discussion has been generally available.

The sections dealing with description and evaluation of equipments form a particularly useful listing of hardware largely because of the objective comparison found in the evaluation sections. The fact that additional equipment and new evaluation sheets can be added substan-

tially strengthens the value of such a catalog because of the rapid pace of advancement in our industry.

The true value of such a service as offered by *The Computer Display Review* will essentially be determined by how well the up-dating task is carried out. If the volume is not frequently serviced, its timeliness, and hence its value, as a source of current display technology will decrease. I would expect that the professional quality reflected in the initial issue of *The Review* would be extended into the maintenance task. — L. M. SEEBERGER, *SID Publications Chairman*.

**Fundamentals of Display Systems** by Harry H. Poole. Published (1966) by Spartan Books, Washington, D.C., and MacMillan and Company, Limited, London. 403 pages + x pages. \$19.50

A better title for this book might have been *A Compendium of Display Systems*, for it is a reasonably well-written and comprehensive description of virtually every device, equipment, system, and technique used to present visual information to an observer.

The underlying fundamentals of the displays described in this book are really

developed in the fields of geometric-physiological-physical- and electron-optics, solid state physics, mechanics, etc., all of which are briefly touched upon but hardly in a fundamental manner. In fact, the entire approach to the subject material is pragmatic including such nonfundamental information as trade names of devices, military specifications imposed on general electronic equipment, "... methods of bypassing environmental restrictions", and considerations in the design of power supplies.

The book is divided into five parts and four Appendices, Part I—Cathode Ray Tube Techniques, Part II—Other Display Techniques, Part III—Display Systems, Part IV—Related Areas, and Part V—Future Display Techniques.

Part I starts with a brief review of cathode-ray tube principles followed by a narrative description of contemporary specialized cathode-ray tubes (i.e., flat, storage, color, printing, beam shaping, etc.), which leaves the impression that this is the basic building block on which the remainder of the text is to be structured. Very rapidly, however, the author departs from electronic cathode-ray displays into photographic and optical systems, electromechanical devices, solid

state displays and in general the text becomes a stew of everything about displays that can be crammed into 400 some odd pages.

Part II includes chapters on Large Screen Techniques-Projection and Discrete, Individual Display Units (alphanumeric indicators) and Display Peripheral Devices (symbol generators, memories and controls). Part III includes chapters on Introduction to Display Systems (engineering considerations), Television, Radar, Computer Generated Displays, and Miscellaneous Applications (plotters, facsimile, etc.). Part IV deals largely with disciplines involved in designing displays such as Human Engineering and Optics, and ends rather belatedly with a chapter on Luminescence. Part V presents first a chapter on Present Display Performance followed by Future Display Techniques (which really isn't future at all but rather describes present techniques still in a development stage). A strange omission lies in the subsection under Light Modulators where both the Kerr and Faraday effects are mentioned but the more widely used Pockels effect and crystal modulators based on it are left out.

Since mathematical relations, graphs, and tables are not derived or referenced the reader new to the subject matter will not easily be able to pursue research

along any specific line of investigation. References in general are poorly handled since they are found at the end of some chapters, and at the end of the book listed by chapter, but are not indexed to the text. Even when indexed by chapter, references are found in strange places, e.g., Destriau & Ivey's definitive paper on electroluminescence is referenced to Chapter 17, Luminescence, but electroluminescence is introduced in Chapter 7; Soller, Starr, and Valley's classic work on Cathode Ray Tube Displays is found referenced to Chapter 12, Radar Displays (Systems), but cathode-ray tubes are introduced in Chapter 1. Other very basic references have been omitted such as *Electron Optics* by Maloff & Epstein, *Television* by Zworykin and Morton which might have better replaced less fundamental papers.

In attempting to relate all displays in one book the author has inadvertently demonstrated how unrelated many of them are, and in the process dissipated his efforts on fields that are already well documented and to which he brings no new insight. Thus standard television and radar systems could have been omitted and the section on Computer Generated Displays expanded — or the TV and Radar sections could have been restricted to slow scan techniques, unusual scanning geometries, etc. Certainly the space

used for a picture of a typical home television receiver (p. 199) could have been put to better use unless the book is intended for inclusion in a time capsule to be retrieved 1000 years hence.

A glaring omission in any fundamental book on displays is a long overdue and definitive discussion of resolution; the development of relationships between the common measures of resolution in radar, television, optics, photography, etc., would be a great service to workers in the display field.

The book cannot be considered by itself as a text, handbook, or catalog of devices although it contains elements of each of these; however, it does make fairly interesting reading. The narrative descriptions are clear and lucid and in general the writing style and English are good (except for occasional technical vernacular — like the use of the word "monochrome" to mean black and white).

Some of the devices and techniques described may shortly become electronic oddities and as such have little lasting value to designers of displays. For the most part, however, many practical approaches to the design of displays are described in the book which is largely hardware and equipment oriented, and it is here that the book's true value must be measured against its cost. — R. A. DAVIDSON, Charter Member, *SID*.

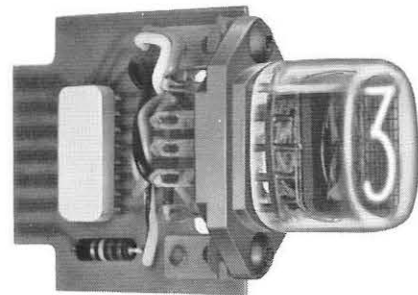

## NATIONAL® Readout Tube Drivers

TTL Integrated Circuit Drivers designed for National Readout Tubes.

Now available: Decoder/Driver and Decimal Counter/Driver.

- 15 MHz Counting Rate
- Compatible with all side view and end view readout tubes.

**NATIONAL** REQUEST BULLETIN  
ELECTRONICS, INC.  
a varian subsidiary  
PHONE: (312) 232-4300 • GENEVA, ILLINOIS, U.S.A.

## LIGHT MEASUREMENT PROBLEMS?

**CHECK GAMMA SCIENTIFIC**

Specializing in instruments and systems for light measurement, Gamma Scientific combines experience, innovation and craftsmanship in its broad line of products, including:  
Photomultiplier Photometers • Calibrated Light Sources • Telephotometers • Photometric Microscopes • Complete Accessories.

For the latest catalog contact: Sales Manager, Dept. 302, Gamma Scientific, Inc., 5841 Mission Gorge Road, San Diego, Calif. 92120. Specific problems? Call collect 714-282-2178.



"See us at ISA Show, Booth 1107"

**GAMMA SCIENTIFIC, INC.**

## DIALIGHT READOUTS

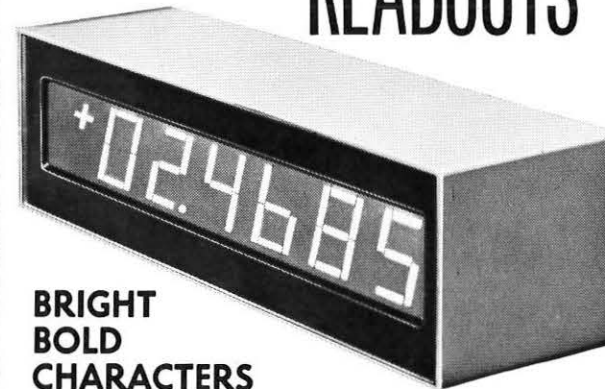

BRIGHT  
BOLD  
CHARACTERS  
WITH  
MAXIMUM  
RELIABILITY

Need more data? Ask for Catalog L-181.

Modular Display

**\$4.75**

per digit  
1000 lot quantities

**DIALCO** Foremost Manufacturer of Indicator Lights  
**DIALIGHT** CORPORATION  
60 STEWART AVE., BROOKLYN, N.Y. 11237 Area Code 212 497-7600



## MINIATURE NEON PILOT LIGHT ASSEMBLIES

1-piece body ideal for space limitations. BNE SERIES has compact lens system protruding slightly above panel. BNF SERIES' lens system extends more for greater illumination. BND SERIES' pilot assembly protrudes beyond panel to provide maximum light intensity.

**ALCO ELECTRONIC PRODUCTS, INC.**  
LAWRENCE, MASSACHUSETTS



## LOW COST \$9.95 NUMERIC READOUT

MINIATURE SIZE, compact, incandescent numeric readouts have new-type, long-life 30,000 hour lamps. Machined aluminum stack-plate design permits close side-by-side mounting. Digit size 3/4" high. Specify 6V or 14V model.

QUANTITY PRICES AVAILABLE

SHIPPED PREPAID WHEN CHECK ACCOMPANIES ORDER  
**ALCO ELECTRONIC PRODUCTS, INC.**  
LAWRENCE, MASSACHUSETTS

WHEN  
YOU CAN'T  
AFFORD  
TO FAIL,  
USE

Magneline®



CUT-AWAY VIEW

Men in space rely on Magneline Digital Indicators and you can too. Sharp black and white digits are positioned electromagnetically. The number drum rotates on a polished shaft in a jewel bearing. Coil assemblies are encapsulated in heat and shock resistant epoxy. Test units have been run through 35 million cycles without failure or measurable wear. Digit sizes range from  $\frac{7}{32}$ " x  $\frac{11}{64}$ " for air and space craft mounting to jumbo models for control towers, mills and foundries.

WRITE FOR  
OUR TECHNICAL  
BROCHURE

Manufactured under U.S. Patents:  
2,943,313; 3,009,140; 3,118,138;  
3,201,785

PATWIN  
ELECTRONICS

A DIVISION OF  
THE PATENT BUTTON COMPANY  
WATERBURY, CONN. 06720

Circle Reader Service Card No. 50

## new technical products

### Deflection Amplifier

Beta Instrument Corp., Newton Upper Falls, Mass., announces the availability of an all-silicon solid-state molecular deflection amplifier. The package features high deflection performance characteristics at an economical price, according to the manufacturer. Designed for application in any CRT or storage tube display system employing magnetic deflection, the unit is a dc coupled operational-type difference amplifier.

Capable of supplying up to 12 amps of deflection current to a directly-coupled deflection coil, the module has two identical channels of power amplification — one for X deflection and one for Y deflection. Outstanding features include excellent linearity, wide bandwidth, and stable operation, according to Beta. Because the amplifier is dc-coupled throughout, it may be utilized in random point plotting or alphanumeric deflection applications as well as for raster or other periodic scan formats.

Circle Reader Service Card No. 51

### Video Amplifier

Beta Instrument Corp., Newton Upper Falls, Mass., announces the availability of its Model VA548 video amplifier, for CRT and storage tube display systems. It is a dc coupled, 10 Mhz, all-silicon, solid state amplifier which features plug-in convenience with economy, according to Beta. The unit is a feedback amplifier, to provide optimum linearity and gain stability, and it may be directly coupled to the CRT grid or ac-coupled to a dc restoring level. The unit is also reported to be fully compatible with all other modular display system components manufactured by Beta.

Circle Reader Service Card No. 52

### Circuit Indicator

Electro-Mechanical Instrument Co., Perkasie, Pa., manufacturers of voltmeters, ammeters and circuit indicators, has introduced a new miniature circuit indicator, the Model 802. Requiring only 2 milliwatts of power to operate, and measuring only 0.406 in. (length) by 0.468 in. (width) by 0.406 in. (height), it finds application as a battery condition indicator, circuit monitor, and similar uses as an indicator of voltages so low that a pilot light will not operate. It is available in both flag-type and pointer-type configurations.

Circle Reader Service Card No. 53

### Microcircuit Step/Repeat

Royal Zenith Corp., New York, offers its Misomex step and repeat Model 101 (a complete re-design of the firm's Model 2943) which features vernier setting step dials which can be set to 0.00005 inch. Magnifying readers are mounted on both the X and Y dimensions to dry run and check results before the master plate is actually produced. The entire unit is compact and operates in both axis fully automatically, according to the manufacturer.

Circle Reader Service Card No. 54

### Multiplex Fiber Optics

Poly-Optic Systems Inc., Paramount, Calif., has announced a new type AST polymer fiber light bundle that offers many advantages over the glass type, according to the manufacturer. Termed Multiplex® bundles, they provide improved flexibility and are almost indestructible. The bundles reportedly provide transmission characteristics superior to glass, especially in the ir and violet regions of the spectrum. Light loss from bubbles and chipped cladding is eliminated. Non-breakable characteristics allow the use of a thin, lightweight sheath rather than the bulky stainless steel convoluted tube usually required with glass. Two types of light sources are available.

Circle Reader Service Card No. 55

### Readout Indicators

Alco Electronic Products Inc., Lawrence, Mass., announces the availability of its series of readout indicators for high intensity display. Brightly-illuminated  $\frac{3}{8}$ -in. digits are indicated on an engraved lucite plate; the figures are marked as a series of white dots. The plate is edge-lighted by a new type of incandescent lamp, the firm states.

The lamps, which are soldered in place to reduce improper-contact problems, are stated to have a life expectancy of from 30,000 to 50,000 hours. Overall size of the indicators is  $2\frac{1}{2}$ -in. high by  $\frac{3}{8}$ -in. wide; narrow width is stated to allow more readouts to be installed and displayed in limited space areas. The units are available in 6- and 14-volt models.

Circle Reader Service Card No. 56

### DC Differential Amplifier

A dc differential operational amplifier (Model 301) which is stated to provide orders-of-magnitude better offset, drift, noise and common-mode performance than present-day FET amplifiers is available from Analog Devices Inc., Cambridge, Mass. Completely solid-state, the 301 is fully encapsulated into a 2.8 in. by 0.9 in. module for direct mounting on printed circuit cards.

Typical applications for the 301 include: integrators with time constant of an hour or more, very low noise amplifiers, pre-amplifiers for operation with piezoelectric and other high impedance sources, differential amplifiers requiring high levels of common mode voltage, follower amplifiers with the minimum of source loading, logarithmic and other wide dynamic range amplifiers requiring signal swing over nine orders-of-magnitude, sample-and-hold amplifiers capable of storing low-level signals on small value capacitors, and combinations of the above requirements.

Circle Reader Service Card No. 57

### 200-W Short-Arc Lamps

Illumination Industries Inc., Sunnyvale, Calif., has announced a series of 200-w mercury short-arc lamps with five luminous efficiencies up to 50 lumens/w. Termed

INFORMATION DISPLAY, SEPTEMBER/OCTOBER, 1966



SUCCESSFUL  
STEPS TO COMPUTER  
AIDED GRAPHIC DESIGN

Take a giant step with Benson-Lehner's new family of graphic digitizing and reduction systems. Now, for the first time, you can build a system to fit your current requirements or your future needs — easily, efficiently and economically.

With the Large Area Record Reader (LARR-V), digitizing of engineering drawings, plans, and maps with output to punched paper tape or punched cards is quickly accomplished. For high volume jobs, an IBM compatible 556 bpi magnetic tape output is available.

For precise printed circuit artwork, the field proven Graphic Artwork Reduction Digitizer (GARD) system has unequalled capabilities. The GARD is adaptable for use with all coordinatographs or the LARR-V.

GARD output is directly usable for numerical control, computer or drafting systems. Resolutions of .001", .010", .050", .100", .250" and .500" are standard. Grid offset, absolute and incremental outputs, and special commands are all included with GARD.

For computer aided design — simple or complex — rely on Benson-Lehner for proven systems every step of the way.



benson-lehner corporation 14761 CALIFA STREET, VAN NUYS, CALIFORNIA • 781-7100

INFORMATION DISPLAY, SEPTEMBER/OCTOBER, 1966

Circle Reader Service Card No. 58



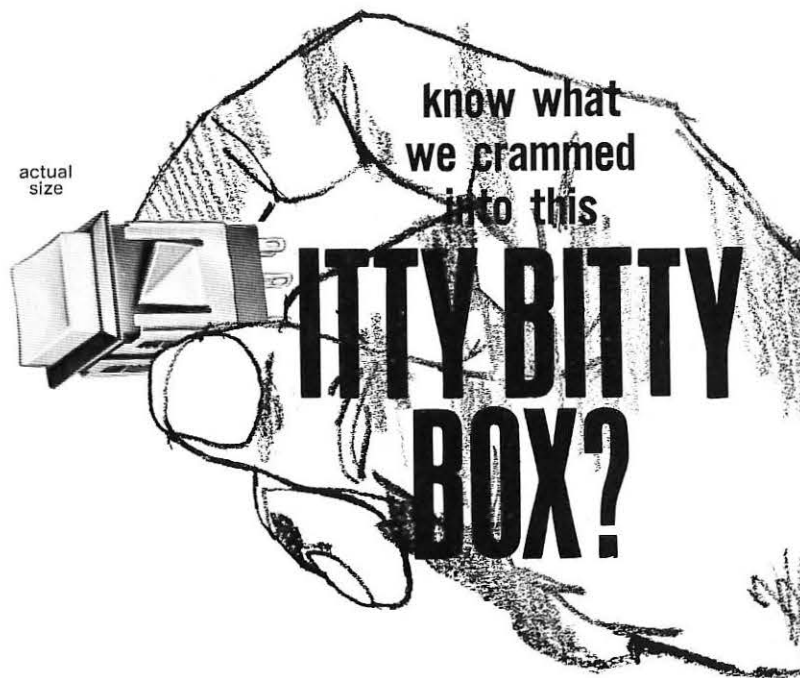

## ALL THIS IN THE SERIES BX BOX SWITCH

- **UP TO 4 POLES OF SWITCHING**  
1-A, 1-C, 2-C & 2-A in this MOMENTARY ACTION pushbutton Switch (or D, F or G contact forms on special order).
- **INTEGRAL SLIDE CONTACTS**  
Silver-plated spring-tempered phosphor bronze contacts rated 250 ma., 30 watts max., A.C. non-inductive load.
- **ADJUSTO-CLIP\* PUSH-IN MOUNTING**  
Instantly adjustable clips for front-of-panel "snap-lock" mounting; for panels 3/64" to 17/64" thick.
- **BEST LOOKING BEZEL IN THE BUSINESS**  
Low silhouette bezel pleasingly frames switch button; acts as an attractive escutcheon plate.
- **SUPER SPACE SAVING SIZE**  
Mounts in matrixes on 11/16" centers in either of two planes. Takes only 1 1/8" behind panel depth.
- **CYBERNETICALLY DESIGNED BUTTONS**  
Handsome finger-fitted concave design: choice of white, black, red, green — other colors and/or identifying legends on special order. 7/64" button stroke.
- **MOLDED BODY ENCLOSES CONTACTS**  
Protects against dust and dirt . . . prevents bending or disfiguring contacts caused by excessive handling. Terminal identification molded into case.
- **AND INCOMPARABLE QUALITY, TOO!**  
Built with the very finest materials manufactured in perfectly matched molds . . . with the "solid" feeling action you expect only from the most precisely engineered switches! Ideal for computers, data processors, telephones and telephone equipment, etc. \* Patent applied for

WRITE FOR BULLETIN 169  
**SWITCHCRAFT**  
INC.

5531 Elston Avenue  
Chicago, Illinois 60630

Circle Reader Service Card No. 59



Type III Series, they are capable of operation on either ac or dc, and are available with or without starting electrodes. Construction is of clear, fused quartz, with especially processed tungsten electrodes. They are extremely intense sources of uv and visible radiation.

Either a 2- or 3-electrode type is available in a 4.1- or 4.75-in. overall length, suitable for new equipment designs. They are interchangeable in all existing fluorescent microscopes and other fixed designs, incorporating 200-w short-arc lamps. Advantages claimed include constant output over lamp life, extreme arc stability on dc operation, and compact arc size for easy collimation. Chief applications include photo-resist exposure, photocopying, color TV exposure, uv illuminators, slit illumination, and microscope illumination. Characteristics include luminous flux 10,000 lumens, arc size 0.10 by 0.07 in.; minimum starting voltage 10 kv; average luminance 33,000 candela/cm. sq.; average dc-operational-life 400 hrs.

Circle Reader Service Card No. 60

### Variable-Scan TV Monitor

ITT Corp's Industrial Products Div., San Fernando, Calif., has introduced an all-solid-state 17 in. variable-scan-rate television monitor with unusually high resolution. It can reportedly accept a variety of fast horizontal scan rates and horizontal axis drive. Its unbalanced wideband horizontal amplifier will accept a 15-kc sawtooth without requiring large amounts of power. Maximum spot velocity is 1 cm/microsec forward (positive) and 3 cm/microsec for retrace (negative).

A 15-kv acceleration potential and a spherical-faced CRT permit 1000-line resolution at the screen center, and not less than 500 lines elsewhere. Deflection is magnetic and focusing electrostatic. Intensity modulation is provided. The all-solid-state system has a very low drift of less than 5 mm per 8 hrs. Vertical sensitivity is 0.1 v/cm with full-screen deflection to 7 kc; 3 db is down at 50 kc with 1-cm deflection. Horizontal sensitivity is 0.5 v/cm with a 15-kc sawtooth full-screen deflection capability.

Circle Reader Service Card No. 61

### Digital Encoding/Display System

A digital shaft encoder featuring unusual separation between encoding transmitter and digital readout has been announced by Theta Instrument Corp., Saddle Brook, N.J. Up to 10,000 ft. separation will not affect either life or performance. Such distances would result in brush burn-up in conventional systems due to the capacitive discharge from interconnecting cables, according to Theta. In addition, the new Series 10 encoder will directly drive several parallel sets of readouts and printers without the need for either code conversion or further power amplification.

Finding application as an analog-to-digital converter, the encoding system interfaces with readouts and printers rather than digital computers. Specifications include speed at 1500 rpm intermittent, and 1000 rpm continuous. Accuracy and resolution are 1 part in 10,000. Life is 25 million revolutions.

Circle Reader Service Card No. 62

Inter-8 Weave Cables  
Magnetic Shield Division, Perfection Mica

INFORMATION DISPLAY, SEPTEMBER/OCTOBER, 1966

Co., Chicago, offers inter-8 weave cables of unusual design which substantially reduce magnetic field pickup or radiation. Cables can be fabricated with compatible alloy wires for thermocouple applications, with plain copper wire for applications where junction EMFs are a problem, or with tinned wire. Increased magnetic or electrostatic shielding effectiveness can be realized by weaving outer shielding braids of Co-Netic or copper over the basic cable.

Dielectric separation between dual layer sheaths is normally PVC but other insulating media may be used. On braided shields, a final insulating outer jacket is used. Wire sizes range from 24 to 36 AWG. Wire insulation can be PVC, Teflon or any other desired dielectric. Cables of No. 24 AWG wire are available in continuous lengths up to 2,000 feet. Continuous length limitation is a function of wire size. Inter-8 cables using special wire can be fabricated in small lots for experimental and special application requirements.

Circle Reader Service Card No. 63

### Precision Film Reader

Richardson Camera Co. Inc., Phoenix, Ariz., has designed a precision film reader, the 660, which will enable an operator to make semi-automatic measurements of X, Y, and O coordinates along with providing entry of auxiliary data into punched card records of images recorded on 16, 35 and 70 mm sprocketed film formats with high speed and comparator accuracy. The unit features low distortion optical projection with automatic selection of 5X, 10X, and 20X magnifications.

The choice of bi-directional film transport modes offered include single frame, multiple frame to frame, variable cinemation (all pin registered), and fast flow motion. The entire transport and buffered film reel system are mounted on an X-Y stage. Digitization of this joy stick manipulated stage provides coordinate readout accuracies of better than 10 microns. A rotatable retical and separate light source are used to provide reference for O and X, Y measurements. This retical is mounted in the proximity of the movable film frame stage so that the image of the film frame and the image of the crosswire retical are both projected through the same objective lens. This not only eliminates error due to lens distortion but abates any error due to lens vibration. The reader has been designed to afford maximum reliability, ease of operation, maintainability and safety.

Circle Reader Service Card No. 64

### Pushbutton Random Access

A new development from Houston Fearless, Los Angeles, called the FilmCARD Reader (patent pending), gives 4-second access to any page in a total file of 67,500 microfilmed pages. The desired record, selected by pushbuttons on the control panel, is located and displayed full size on a screen at the front of the Reader. The unit is a desk top, self-contained, microfiche reader which contains a file of up to 750 filmcards (microfiche), each of which contains 90 microfilmed pages, providing a total of 67,500 pages of information. Any amount of additional file storage can be contained in external magazines and be quickly interchanged with identical

magazines in the Reader.

Operation is by use of a standard 115 v, 60-cycle, ac outlet. Overall size is approximately 16 in. by 22 in. by 21 in. Custom models are available to specifications. Special optional features include a printer for hard copy output, increased internal capacity to 100,000 pages, COSATI and NMA formats, random access computer peripheral equipment, dual screen models, look-ahead, replaceable storage files, and numerous other features.

Circle Reader Service Card No. 65

### Subminiature Neon Lamps

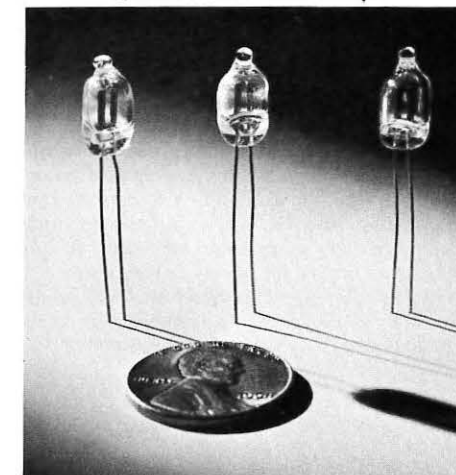

Two new subminiature neon glow lamps, the A1B and the A1C, have been introduced by Signalite Inc., Neptune, N. J. for use as indicators in appliances and other

## WHY THE WORLD'S SMALLEST READOUTS?

TO USE WHERE HIGH INTENSITY, LOW POWER, LONG LIFE, LIGHT WEIGHT  
AND SMALL SPACE ARE REQUIRED -- NO MOVING PARTS!

qualified for aircraft use/ designed for avionics, ordnance, shipboard applications

**DIRECT VIEWING** of incandescent light bars (no projection . . . no light-piping) permits: **lowest power** of any device — total power, from 50 milliwatts;

**wide viewing angle** since all light bars are on the same plane; **excellent readability** even in direct sunlight; **smallest volume to character height.**

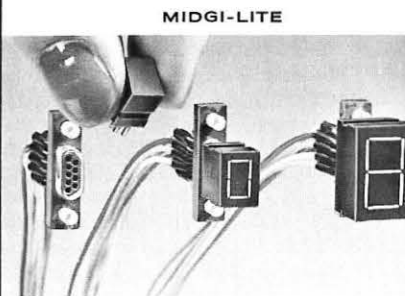

The digital readout (MIDGI-LITE) is available in 5 standard sizes\* with character heights from 1/8" to 1/2" . . . the alpha-numeric readout (ALPHA-LITE) is available in two standard sizes\* with 1/4"

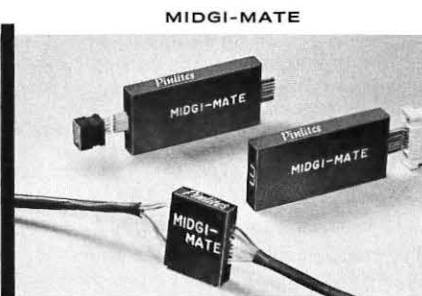
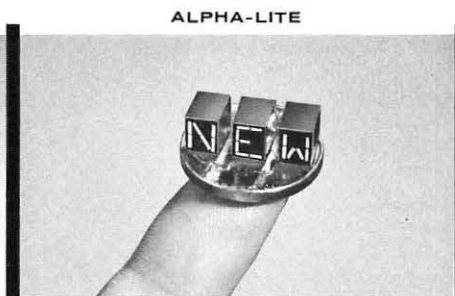

and 3/8" high characters. Encoders and drivers (MIDGI-MATE) are available to mate with all MIDGI-LITES and ALPHA-LITES. All are offered with a variety of terminations.

\*CUSTOM SIZES AND SYMBOLS AVAILABLE TO MEET YOUR REQUIREMENTS . . . WRITE OR CALL TODAY

**Pinlites Inc.** 1275 BLOOMFIELD AVENUE, FAIRFIELD, N. J. 07007 / (201) 226-7724

INFORMATION DISPLAY, SEPTEMBER/OCTOBER, 1966

Circle Reader Service Card No. 66

devices. The A1B is a standard brightness lamp and the A1C is a high brightness lamp. Light output of the high brightness lamps generally runs approximately ten times that of the standard brightness lamps and can be readily observed under normal room lighting conditions. Standard brightness lamps are used where normal lighting conditions are low and a lower light level is desired, such as on electric blankets.

Both lamps are supplied in a clear glass tube which is 0.244 in. max. in diameter and 0.5 in. max. in length. Leads are 1 in. copper. The lamps may be provided with or without a current limiting resistor in accordance with specifications.

Circle Reader Service Card No. 67

#### High-Speed Stroke Writers

A series of high-speed stroke writers that can produce symbols for CRT displays at speeds as fast as 4  $\mu$  sec per symbol has been announced by Tasker Instruments Corp., Van Nuys, Calif. A patented function-generation technique permits customizing modular printed circuit cards to give unlimited character style and repertoire, as required by specific programs or control circuits. Adaptable to either high-speed, random-access writing systems or formatted systems, the Model 401 can operate from remote location (up to 50 feet) and can drive as many as 50 nonparallel displays.

Cards can be custom-built to produce virtually any shape of symbol, figure, or character that can be made up of 20 or fewer straight line segments. Line segment length and direction are not limited and

all symbols are written with continuous, connected line segments at a constant rate that assures uniform line intensity and brightness.

Circle Reader Service Card No. 68

#### Microwave TV Transmitter

Brown Engineering Co.'s Electronic Systems Div., Huntsville, Ala., has developed a solid state microwave television transmitter weighing less than 10 lbs. Designed for operation on an S-band frequency, the unit has applications in closed-circuit TV systems for aerospace, industrial and educational purposes.

Measuring 1 ft. long by 4 in. high, the transmitter is in a sealed aluminum-magnesium housing that permits operation in all environments, including outer space and underwater. It produces 20 milliwatts at 2280 megacycles and operates on 28 w (after warmup). Its simplified design is reported to: utilize fewer and smaller components; require less power than similar units; and be highly reliable and rugged. The unit reportedly can be utilized with any TV equipment having a 75-ohm input impedance.

Circle Reader Service Card No. 69

#### Miniature Decade Counter

United Computer Co., Tempe, Ariz., announces the manufacture of its Model F1842 integrated circuit decade counter. The unit is 1-11/16 in. high allowing use in thin 1 1/2 in. high rack mounted systems. New bright inplane display has 3/8 in. high numbers and can be read over wide viewing angles.

Decades mount on 1 in. centers. Counting speeds are dc to 3 million counts per second. The unit is available with 10-line decimal or BCD electrical output. Supply voltage is a 3.3 v at 120 ma. for logic and 5 v ac 60 to 400 cycles for lamps. Single voltage models are also available. The unit measures 1-11/16 in. H x 1 in. W x 5 1/2 in. L; weight is 3 ounces.

Circle Reader Service Card No. 70

#### High-Sensitivity CRT



Amperex Electronic Corp., Hicksville, L.I., N.Y., announces the D13-27 CRT which features high sensitivity for its length and face size. It is a 5-in. round flat-face general-purpose display tube intended for use in precision instruments. Its short length of 13.5 inches makes it especially suited for use in transistorized equipment. The tube features electrostatic focusing and deflection and incorporates a helical distributed P.D.A. system. Its vertical sensitivity is 13 v cm and horizontal sensitivity is 27 v cm.

Useful scan area is 8 x 12 cm, and spot size is 0.012 in. The Amperex D13-27 utilizes deflection blanking electrodes, thus allowing blanking circuitry to be referenced to ground.

Circle Reader Service Card No. 71

#### Video Converter

Colorado Video Inc., Boulder, Colo., has introduced a video converter which provides a "slow-scan" TV signal from standard "real-time" video inputs. Completely solid-state, the unit achieves conversion by means of sampling rather than storage tubes, thus providing superior resolution, grey scale, and shading characteristics, according to the manufacturer.

The model 201 may be used for narrow-band visual communications, video processing, or as a computer input device for data analysis. Slow-scan frame rates are variable from 5 to 60 seconds, and either analog or digital outputs may be selected.

Circle Reader Service Card No. 72

#### Drum Type Incremental Plotters

California Computer Products Inc., Anaheim, Calif., announces the availability of its Models 665 and 663 drum-type digital incremental plotters which operate at asynchronous incremental step rates up to three times the speed of standard Models 565 and 563. Compatible with all CalComp on-line interface units and off-line tape units (Models 470, 750, 760, 770 and 780), electronics are mounted in a desk style console.

The plotters provide switch selection of either 0.01 in. or 0.005 in. step size. Model 665, with a 12-inch drum, operates at incremental speeds of 900 steps/sec. in 0.005 in. step size and 450 steps/sec. in the 0.01 in. step size. Model 663, with a 30-inch drum, operates at corresponding speeds of 700 and 350 steps/sec.

Circle Reader Service Card No. 73



If you switch signals  
...you need this book.  
(It's FREE from DYNAIR!)

Yes, for a limited time only, you can receive a free copy of this helpful new book, with absolutely no obligation! Just mail the coupon.

Published by DYNAIR, the leading manufacturer of video distribution switching equipment, this book describes the most commonly used methods of switching video and other high-speed information.

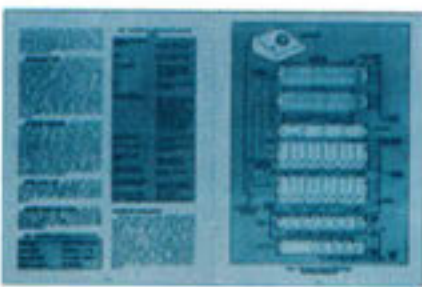

The photographs shown are sample pages reproduced directly from "Video Switching Techniques" and are typical of the material presented. Pictorial diagrams, supported by easy-to-understand text, charts and tables, make system design simple.

The book includes useful design information for a multitude of systems, both video and audio... simple and complex. (High-speed data can be switched using the same techniques.) It covers everything from a basic single-output monitor switcher to complex dial-controlled, solid-state switching systems which can

control hundreds of inputs and hundreds of outputs. The problems involved in selecting the basic type of switcher for a particular application are discussed with the exact equipment detailed for many systems.

DYNAIR switching equipment is installed in numerous facilities throughout the world. We have supplied remote-controlled, solid-state systems with as many as 14,000 crosspoints. One system provided independent selection of 135 inputs by 390 separate monitor locations—probably the world's largest solid-state switching system.

The practical building-block construction techniques used in solid-state DYNAIR equipment allow systems of virtually any size to be easily assembled. Plug-in modular etched circuit boards are used throughout, assuring ease of maintenance. Custom control panels can be provided to suit almost any requirement.

DYNAIR also manufactures a variety of other television equipment,

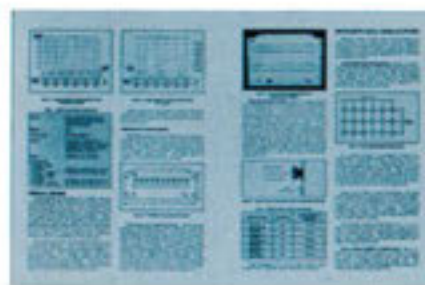

including solid-state modulators and demodulators, solid-state modular video amplifiers, and solid-state side-band analyzers.

If you use this type of equipment, you might like to receive either our complete catalog or literature on specific devices; DYNAIR product information is available upon request—just write, outlining your needs.

**DYNAIR**  
ELECTRONICS, INC.  
SAN DIEGO, CALIFORNIA

6360 FEDERAL BLVD. • SAN DIEGO, CALIF.  
ZIP 92114 • PHONE (714) 582-9211

Please send me a free copy of "Video Switching Techniques"

NAME \_\_\_\_\_

TITLE \_\_\_\_\_

COMPANY \_\_\_\_\_

ADDRESS \_\_\_\_\_

CITY \_\_\_\_\_

STATE \_\_\_\_\_ ZIP NO. \_\_\_\_\_

## MAGNETIC SHIELDING MADE EASY

APPLIED IN SECONDS  
Cut to any size or outline  
with ordinary scissors

Co-Netic and Netic foils are ideal for initial laboratory or experimental evaluation... also for production applications and automated operations. Dramatically enhance component performance by stopping degradation from unpredictable magnetic fields. When grounded, foils also shield electrostatically. They are not significantly affected by dropping, vibration or shock, and do not require periodic annealing. Available in thicknesses from .002" in rolls 4", 15", and 19-3/8" wide. High attenuation to weight ratio possibilities. Every satellite and virtually all guidance devices increase reliability with Netic and Co-Netic alloys, saving valuable space, weight, time, and money.



## MAGNETIC SHIELD DIVISION

Perfection Mica Company

1322 N. ELSTON AVENUE, CHICAGO 22, ILLINOIS

ORIGINATORS OF PERMANENTLY EFFECTIVE NETIC CO-NETIC MAGNETIC SHIELDING

## CRT DISPLAYS to

LARGE SCREEN COLOR DISPLAYS

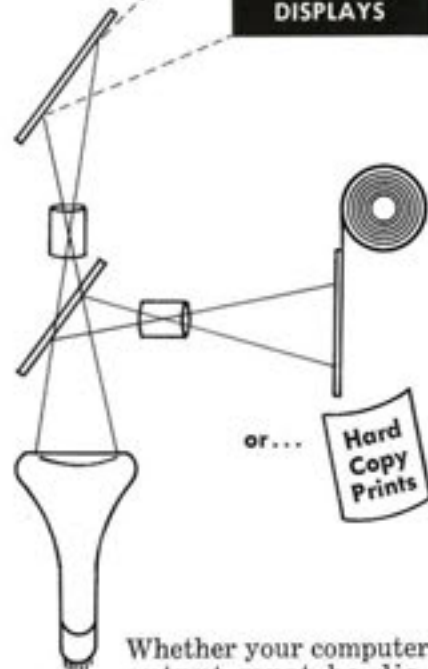

Whether your computer output must be displayed to a group for management or command decision, or permanently recorded for analysis, a Photomechanisms system will do it for you most efficiently.

**Large Screen Display Systems** by Photomechanisms photographically record monitored events and display them in a variety of colors in near real time. Present systems are particularly well suited to applications where large amounts of data must be displayed and changed regularly.

**Hard Copy Generating Systems** by Photomechanisms can be custom assembled from modular subsystems to meet your specifications for capacity, sensitivity, and cost. Four basic systems are currently available to fit most applications.

Fast, full-color display for decision making or clean, permanent prints for record and analysis—Photomechanisms engineers can help you do what you want with your computer output. Drop us a line today.

PHOTOMECHANISMS Incorporated

15 Stepar Place, Huntington Station, New York 11746

86

Circle Reader Service Card No. 76

### Multistation Annunciators

New 276 Series annunciators, developed by the Korry Manufacturing Co., Seattle, Wash., provide complete programs of indications for the sequenced operations of a system or for monitoring the status of several systems simultaneously. Featured are captive legend-lampholders desirable for airborne equipments. Each indicating lampholder contains two T 1½ midget flange base lamps which are removable from the front of the assembly without use of tools. Depression of the lampholder releases an internal latch mechanism, allowing the lampholder to be extracted. Pivoting the lampholder on the retaining pin exposes the lamps for replacement.

The annunciators are fabricated in a wide variety of arrays to suit individual requirements. Custom engraving is accomplished in a legend space of 0.35 by 1.1 inch. Translucent white plastic legend plates light red, green, blue, amber, or white when the lamps are illuminated.

Circle Reader Service Card No. 77

### Additive Color Rear Projector



Giannini Scientific Corp., Santa Ana, Calif., announces the design and development of an additive color rear projector 70 mm viewer to be used in conjunction with multisensor reconnaissance records, under the sponsorship of Rome Air Development Center, Griffiss AFB, N.Y.

The projector incorporates three additive color channels and one reference channel. A stereo bridge can be mounted for stereo viewing. The four channels can be simultaneously or independently scanned in x and y modes and are also independently adjustable for x and y translation and image rotation about the optical and x and y axes. Each channel has 5X, 10X, and 20X magnifications variable  $\pm 5\%$ , and incorporates a film transport accommodating 100 ft. of 70 mm unperforated film. Two rear projection screens are provided for viewing, each equipped with a movable 3X loop for additional magnification.

Circle Reader Service Card No. 78

Display/Recorder  
Straza Industries' Data Handling Dept.,

El Cajon, Calif., announces production of its Model 1131 Display/Recorder. The unit utilizes a 16-in. CRT (P-7 phosphor) for visual display of up to 2048 alphanumeric symbols. Symbols can be placed at any of 1024 x 1024 random locations on the screen, or the equipment can be commanded to operate in an increment mode where symbol follows symbol (similar to typewriter operation).

The display is equipped with a light pen which can detect a symbol or a single point on a plotted curve. A manual interrupt button allows skipping to the next frame or switching over to recording. Recording of 6 full frames/sec. takes place on 35 mm microfilm (16 mm optional) with the camera looking at a 6-in. CRT (P-11 phosphor) with flat faceplate.

Circle Reader Service Card No. 79

### Incandescent Pilot Light

Industrial Devices Inc., Edgewater, N. J., has announced the availability of a new incandescent pilot light—the Series 2800 Mini-Slide. This attractive and economical pilot light uses slide-base lamps, fits into an 11/16 in. panel hole, and is available in a variety of lenses including clear, red, amber, green, blue and yellow.

The lamps are said to be extremely long-lived, rugged and reliable, and are available from 4 to 120 v. Relamping is simple and may be done from the front of the panel without special tools. The lamp itself is extremely bright and is easily visible under all ambient light conditions, according to the manufacturer. The Series 2800 assembly is held to the panel by means of a new nylon torque-limiting nut (patent pending) which automatically limits the degree of torque it can be subjected to—thereby eliminating the possibility of stripping the assembly itself.

Circle Reader Service Card No. 80

### Signal Processing Storage Tube

Warnecke Electron Tubes Inc., Des Plaines, Ill., announces the availability of a high resolution version of its dual-gun RW-5 miniature storage tube for video data processing. Designated the RW-5EM, the new tube is capable of resolving a minimum of 1200 TV lines on a target of 1-in.-diam. Storage times from a fraction of a second up to a few minutes can be provided. The tube uses electromagnetic focus and deflection on both write and read sides. In size and shape, the tube is identical to the firm's RW-5, utilized a video data processor in both ground and airborne applications. The tube meets the airborne environmental requirements of MIL-E-5400.

Circle Reader Service Card No. 81

### Implosion-Protected TV Tube

A 25-in. 110° black-and-white television picture tube, described as the largest commercial CRT having its own integral implosion protection system, is available from the Westinghouse Electronic Tube Division, Elmira, N.Y. The rectangular tube, in addition to its implosion protection system, offers other major features such as: over 327 sq. in. viewing area; special tinted glass for improved picture contrast; four integral mounting brackets, or "ears" that facilitate cabinet mounting; and construction that

INFORMATION DISPLAY, SEPTEMBER/OCTOBER, 1966

# FAIRCHILD cleans the beam!

*New electron optics provides unassisted focus and astigmatism correction*

- NO DEFOCUSING WITH DEFLECTION
- NO ASTIGMATISM
- HIGH WRITING SPEED

**Breakthrough at Fairchild!** The Fairchild clean-beam tube, KC 2656, is a new 12-inch electrostatic deflection and focus CRT with a new electron gun. The electron gun design represents a major breakthrough. This design provides increased writing speed and significantly reduced deflection defocusing

and astigmatism, with increased resolution.

Fairchild calls this "the clean beam tube" because of the excellent spot size over the entire useful screen area. Dynamic or programmed correction is not required to compensate defocusing or astigmatism resulting from deflection.

This tube is the result of extensive research and development which produced new departures in deflection structure and electron gun design. The design changes have improved the compatibility between the beam generation and beam deflection functions.

Write or call for informed application assistance on the new KC 2656, or ask for our new 48-page catalog listing over 4,000 tubes that we make.

WORLD'S LEADING MANUFACTURER OF DISPLAY TUBES

**FAIRCHILD**

DUMONT ELECTRON TUBES

A DIVISION OF FAIRCHILD CAMERA AND INSTRUMENT CORPORATION  
CLIFTON, N.J.

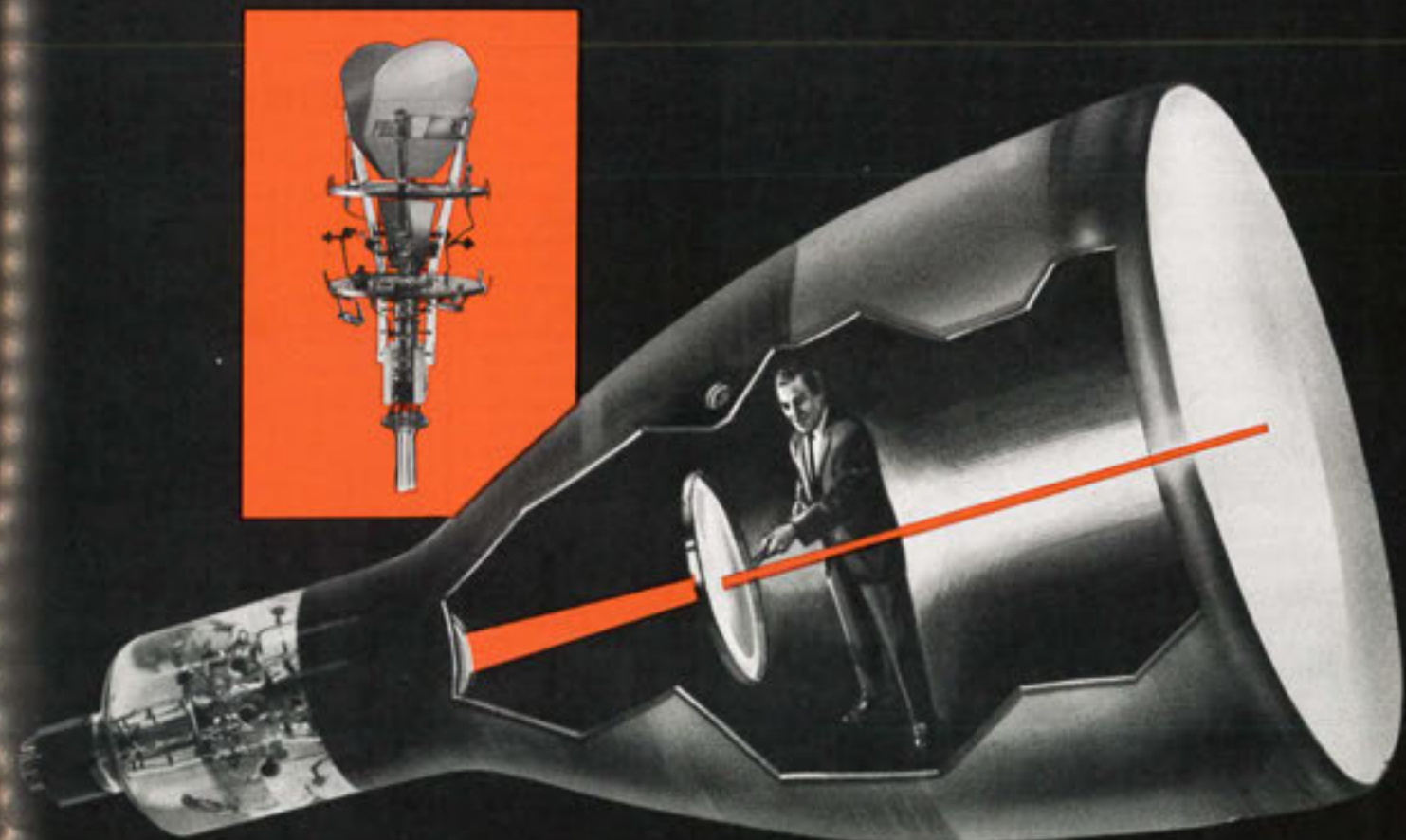

Circle Reader Service Card No. 82

## CRT DISPLAY SYSTEM BUILDING BLOCKS



- CRT AND COIL MOUNTS
- SAWTOOTH GENERATORS
- DEFLECTION AMPLIFIERS
- DYNAMIC FOCUS AMPLIFIERS
- DYNAMIC FOCUS GENERATORS
- LINEARITY CORRECTION CIRCUITS
- VIDEO AMPLIFIERS
- BLANKING AMPLIFIERS
- PHOSPHOR PROTECTION CIRCUITS
- STATIC FOCUS REGULATORS
- AND MORE

Visit us at the SID show,  
Boston, October 18, 19, 20

**Beta  
Instrument  
Corporation**

377 ELLIOT ST., NEWTON UPPER FALLS  
MASSACHUSETTS / TEL. 617 • 980-6510

is adaptable to tube types differing only in electrical characteristics.

The implosion protection system is comprised essentially of a metal rim band and a steel tension strap. The metal rim band, suitably curved to fit snugly around the periphery of the tube face, is epoxy bonded to the glass. A steel tension strap is then prestressed tightly over the rim band and mechanically clinched in place to maintain a residual tension in the system. The mounting brackets are positioned so that the tube can be used interchangeably with tubes using alternative implosion protection, such as the "filled rim" system.

Circle Reader Service Card No. 84

### Portable Netic/Co-netic Chamber

Magnetic Shield Div., Perfection Mica Co., Chicago, offers its portable Netic/Co-netic shielded chamber for performance test evaluation of magnetically-sensitive components or small systems where unavoidable magnetic fields are present. The dual cell isolates sensitive components or small systems from ambient magnetic fields during performance testing, assuring accurate evaluation. The cell measures 30 in. cube inside, has 24 in. x 24 in. shielded hinged door with spring latch, and two shielded cable entries at rear. Dual separate lamina construction consists of Netic S3-5 outer layer for diverting higher level magnetic fields, and Co-Netic AA inner layer for maximum attenuation of low level fields.

Both materials are relatively non-shock sensitive, non-retentive and do not require periodic annealing. Proper spacing and adequate support is provided by a lightweight 3/8 in. aluminum bar stock frame. For complete shielding continuity when door is closed, the Co-Netic layer overlaps the inner shield system. For easy portability, four conveniently-located handles are provided.

Circle Reader Service Card No. 85

### Adaptive Spectrum Analyzer

Federal Scientific Corp., New York, announces production of its Model 60 Ubiquitous™ Spectrum Analyzer for on-line use with dynamic signals. Speech, vibration, shock, and other phenomena with time-varying spectra are among the fields of application. The complete characterization of a signal whose spectral composition varies rapidly is accomplished with coarse frequency resolution and many independent observations per second. In contrast, a signal whose spectral characteristics are stationary is completely characterized through the use of fine frequency resolution and few measurements per second.

The Model 60 synthesizes 10,000 independent frequency resolution elements per second whose frequency-time distribution can be allocated in accordance with signal dynamics. Salient features include: completely simultaneous adaptive frequency analysis over 800 Hz range; bandwidth variable from 25-400 Hz; dynamic ranges to 60 db; ability to capture transients in an internal memory for analysis and playback; optional digital output. The unit is all solid-state, has a 12 1/2-in. front panel, and power consumption is 75 w.

Circle Reader Service Card No. 86

# Random access slide projector for CCTV



Model 136-SU

- 256 slides
- short-way-home search
- 3.1 second average access time
- ±.0005" slide locating accuracy

CRT overlays / Briefing systems  
Production control / Educational tv  
Dispatching / Surveillance

**MD MAST DEVELOPMENT  
COMPANY**

DAVENPORT, IOWA • Phone 319-323-9729  
Circle Reader Service Card No. 87

## Luxurious and carefree comfort in the heart of BEVERLY HILLS...

110 attractive rooms, pent-house suites with TV and radio surrounded the beautiful figure-eight swimming pool. Delicious dining in the CAFE CARLTON. Continental flavor in service and styling. ONLY STEPS AWAY FROM THE FABULOUS BEVERLY HILLS SHOPPING AREA.

A LEE HOTEL



from \$10 Single

For Reservations  
in New York: Plaza 2-5600  
in Chicago: State 2-5835

## THE BEVERLY CARLTON

9400 W. Olympic Blvd., Beverly Hills  
Phone: CRestview 5-5221  
Teletype 213-278-3798

Circle Reader Service Card No. 88

INFORMATION DISPLAY, SEPTEMBER/OCTOBER, 1966

### Transient Record/Reproducer

Evans Associates, Berkeley, Calif., has introduced its Model 848 transient recorder/reproducer, which will record single transient events, or selected intervals of continuous analogue data. Input signals, ranging from sub-millisecond down to minutes duration, are sampled, stored, and are available at any subsequent time desired. The basic Model 848 reproduces 256 sequential data points in time, with a provision for adding on, in modular fashion, 1024 or 4096 additional points.

The reproduce mode is non-destructive; consequently, the stored signal may be regenerated continuously as a repetitive waveform. Other features provided are automatic smoothing on output, a connection for computer programming, and point-by-point interrogation. Applications include making Fourier analyses of fast and slow transients, utilizing conventional oscilloscopes in displays requiring storage, and recovering elusive, once-only waveforms.

Circle Reader Service Card No. 89

### Digital Shaft Encoder

A digital shaft encoder featuring unusual separation between encoding transmitter and digital readout has been announced by Theta Instrument Corp., Saddle Brook, N. J. Up to 10,000 feet separation will not affect either life or performance, Theta states. Such distances would result in brush burn-up in conventional systems due to the capacitive discharge from interconnecting cables.

The Series 10 encoder will directly drive several parallel sets of readouts and printers without the need for either code conversion or further power amplification. Finding application as an analog-to-digital converter, the encoding system is novel because it interfaces with readouts and printers rather than digital computers. Specifications are: speed, 1500 rpm intermittent and 1000 rpm, continuous; accuracy and resolution, 1 part in 10,000; and life, 25 million revolutions.

Circle Reader Service Card No. 90

### Random-Access Projector System



Spindler & Sauppe Inc., Glendale, Calif. announces the introduction of a 192-slide capacity projector system capable of complete random-access slide selection, called

INFORMATION DISPLAY, SEPTEMBER/OCTOBER, 1966

the Selectroslide.

Two Selectroslide projectors are electrically coupled to a specially-designed control console. Both projectors focus on the same screen (either front or rear projection), providing a total of 192 slides. Random selection and projection of all slides, as well as focus adjustment and on/standby switching of both projectors, is accomplished by the remote control console.

Circle Reader Service Card No. 91

### Micromin Pushbutton Switches

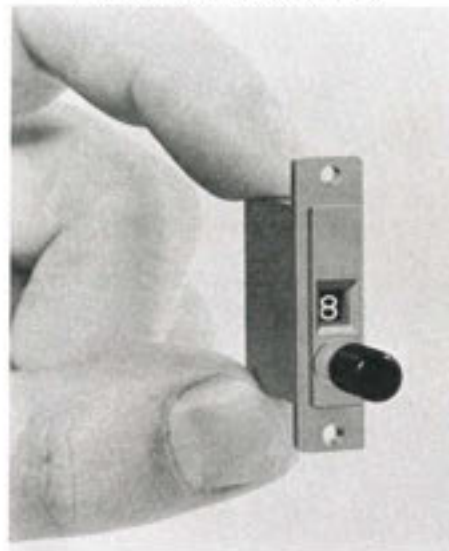

A new line of micro-miniature push-button rotary switches has been announced by Janco Corp., Burbank, Calif., manufacturers of rotary and solenoid operated switches. Featuring printed-circuit construction and extreme ease of operation, this latest Janco pushbutton rotary switch is designed to meet and exceed the environmental requirements of MIL-S-22710.

Called the "Space-Saver" pushbutton rotary switch, it is actuated by depressing the button on the front of the switch. A window is provided for readout where white digits on a black background indicate switch positions. The switch is available in 8, 10, or 12 positions in all standard codes. Mechanical and electrical life characteristics are said to have capabilities of 100,000 revolutions. Electrical rating carries 3 amps continuous, makes and breaks 0.125 amps resistive, and has an initial contact resistance of 0.003 ohms maximum. The switch measures 1.020 x 1.020 x 0.350 wide. Weight is 1 ounce maximum.

Circle Reader Service Card No. 92

### Panel Meters

Ideal Precision Meter Co. Inc., Brooklyn, N.Y., offers its line of panel meters, including a series of eight sizes of oblong meters measuring from 1 1/2 in. to 7 in. The meters feature "vision-depth" styling for functional beauty; rim-to-rim scales for easier, more accurate reading; and rugged construction of high-impact thermoplastic material.

Ranges of the meters are for all standard dc types and ac rectifier types. Other series types which are available include a new group of long-scale 4-inch panel meters which have 250° arc scales.

Circle Reader Service Card No. 93

### Digital Readouts

Tung-Sol Electric Inc., Newark, N.J., has introduced single digit readouts, each capable of representing 21 standard alphanumeric characters in a seven segmented bar configuration. Single digits are stacked together to form desired word length and are held in place by a lightweight frame which also serves as a mounting bracket. Miniature incandescent lamps and specially-silvered light pipe segments achieve, reports Tung-Sol, the highest practical brilliance in the industry (500 ft.-Lamberts min.). The units are reported to feature 150° wide angle viewing, negligible surface reflections, and unobstructed in-plane, in-line presentation.

The units are reported to be particularly suitable for semi-conductor circuitry and mobile applications because of their low voltage requirements, small size, light weight, and ease of maintenance. Electrical requirements are 4 v ac/dc and 0.070 amp/lamp (8 lamps/digit). The readouts have been designed and tested to withstand the requirements of MIL-E-5400, according to Tung-Sol.

Circle Reader Service Card No. 94

### Radar Recording System

Precision Instrument Co., Palo Alto, Calif., is manufacturing and marketing its new PI-7100 Radar Recording System. The system (consisting of a PI-7100 broadband video and instrumentation magnetic tape recorder and a radar interface coupler) is capable of recording up to 85 minutes of continuous or intermittent radar data on a 10 1/2 inch reel containing 3600 feet of 1-inch video tape. Utilizing the PI-7100, it is possible to record complete 2D radar information, including single speed synchro information and composite video signal composed of radar video mixed trigger video bandwidth of 4.0 Mc. The antenna azimuth information is recorded on one auxiliary track to provide an absolute position. A second auxiliary track is available for voice annotation.

Upon playback, the interface equipment extracts pulses from the composite video, trigger signals for the PPI and synchro position information for the PPI azimuth servos. Some of the broader applications for the system include playback of weather information, detailed analysis of flight formations and training. The stop-scan and vari-scan features of the system provide for long term analysis of single frames as well as variable speed playback in both directions.

Circle Reader Service Card No. 95

### Raster Generator

CELCO, Mahwah, N. J., announces the availability of a new raster generator designed particularly for CELCO deflection yoke amplifiers. The instrument is rack mounted and consists of two ramp generators biased ± 5 v about ground with continuously variable control. Each has four overlapping sweep period ranges providing continuous adjustment from 20 microseconds to 100 milliseconds. Rasters with a wide range of frequencies can be quickly displayed. The unit measures 19 in. by 8 1/2 in. by 10 in. and weighs 10 lbs.

Circle Reader Service Card No. 96  
(Continued on page 92)

## How can you get the most squint-proof detail on closed-circuit TV?



Unretouched photo of monitor screen

## Granger Associates has the answer

**now** G/A's new high-resolution TV system lets you read a letter or digit occupying only 1/15,000 of the picture area. You can view broad scenes—like a situation display, an airport runway, or a bank of panel meters—and see all the critical details. Or you can put an entire letter-size document on the screen and read any part. Series V1000 TV systems use as many as 1225 scanning lines and a 30 Mc video bandwidth to produce pictures with four times the clarity of conventional 525-line, 8 Mc systems. Get in touch with G/A for the most advanced closed-circuit TV systems available anywhere today.



**Granger Associates**

AN EQUAL OPPORTUNITY EMPLOYER

1601 California Ave., Palo Alto, California / Telephone: 321-417 5/ TWX: 910-373-1291  
Granger Associates Ltd., Fox Oak (Flat), Seven Hills Road, Walton-on-Thames, Surrey, England / Weybridge 44842

Circle Reader Service Card No. 110

(Continued from page 53)

BROWSE/ or light-penning the appropriate BROWSE symbol.

The system responds to the BROWSE command with

### INPUT ATTRIBUTES WANTED

This is the machine's way of asking whether the user wishes to have displayed the title of the article, the author, the index terms, or the complete abstract. If he doesn't know what choices he has, he types

### LIST ATTRIBUTES

and the system responds with

ALPHA  
CORP-AUTHOR  
AUTHOR  
CONTRACT  
XTERM  
DIVISION  
DATE  
TITLE  
ABSTRACT  
\*END

In this instance, the user wishes to see all available information and so he selects ABSTRACT. The system now displays on the scope all available information on each of the documents in descending order. The first abstract to appear on the scope is of document #AD-276082 (Figure 7). Note that the abstract is not complete because of lack of room. The rest of the abstract can be obtained by light-penning the "C" character.

Should an immediate permanent record be wanted, it can be obtained by the command

### TYPE DISPLAY/

In this manner the user can browse through the entire set of 51 entries that have been retrieved in response to his request or that subset of documents that he has not removed from the display. He may save any information that appears for future reference.

### User Satisfaction

The BOLD information storage and retrieval system enables the user to formulate and modify his requests. He may search through the store of available information. He can, on the spot, determine which documents are relevant and which are not. After seeing the abstracts, he can determine and record the number of those documents that he wishes to read in their entirety. He interacts with the system, and when he leaves the inquiry station he leaves with the feeling that he has obtained most of the relevant material that the system has in store. The response has been rapid, and the experience has been a satisfying one.

### References

1. Burnaugh, H. P. Data Base Generator for the BOLD System, SDC Document TM-2306/001/01, January 1966.
2. Burnaugh, H. P. Retrieval Program for the BOLD System, SDC Document TM-2306/002/00, January 1966.

INFORMATION DISPLAY, SEPTEMBER/OCTOBER, 1966



# BRIGHT NEW 19" CRT

This is Sylvania's new 19-inch SC-4448. It gives you high resolution and brightness—even at a writing rate of 1,000,000 inch/sec.

This tube uses the *spiral* approach. For superior display with minimum pattern distortion—and without complicated circuitry.

The helical resistance coating inside the spiral tube allows accelerating voltage to be uniformly increased along the length of the bulb between deflection plates and screen. This permits a higher ratio of final anode voltage to second anode voltage—without excessive pattern distortion.

On the SC-4448, there's a direct-viewed aluminized screen

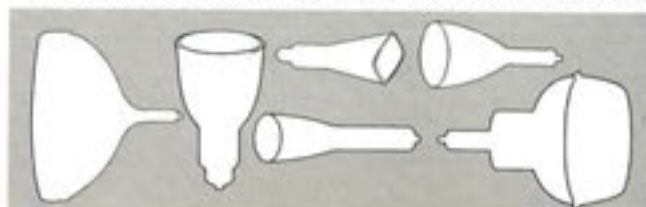

and spiral post deflection acceleration. Deflection plate leads are brought out through the neck—to minimize lead capacitance. Deflection and focus are electrostatic.

And there's a special geometry control electrode for maximum pattern linearity.

For new ideas in CRTs, keep an eye on Sylvania. We introduced low heater power cathodes (1.5V, .140A), electrostatic printing tubes, potted high-altitude CRTs, prealigned packaged assemblies, rear-window 19" display tubes—and 19" spiral accelerator tubes. We can custom-design and fabricate the most sophisticated CRTs you can specify.

Sylvania Electronic Components Group, Sylvania Electric Products Inc., Seneca Falls, New York 13148.

**SYLVANIA**  
SUBSIDIARY OF  
**GENERAL TELEPHONE & ELECTRONICS GTE**

INFORMATION DISPLAY, SEPTEMBER/OCTOBER, 1966

Circle Reader Service Card No. 97

(Continued from page 89)

### Module Socket Kit

Robinson-Nugent Inc., New Albany, Ind., has announced production of its "Make-Your-Own" Module Socket Kit #1, an addition to the firm's regular lines of integrated circuit sockets, fabricated and molded transistor sockets, miniature pin contacts, coaxial cable splices and other products. The kit is reported to be an economical unit containing all of the elements necessary to work up a custom socket assembly for laboratory, prototype or testing applications.

Circle Reader Service Card No. 98

### Printing Machine

Eastern Marking Machine Corp., Island Park, L.I., N.Y., announces the availability of its Model RC/4K high-speed machine for printing flat or slightly irregular products. Pieces placed on a conveyor receive the image from a printing roller as they pass under the printing head. By transposing the two lower rollers, the machine may be converted to direct printing. Printing width is 2 inches, and production rate is between 3600 and 6000 units per hour. Reverse type of economical photoengravings may be utilized with the dry offset method of printing.

Circle Reader Service Card No. 99

### Calibrator & Voltmeter

Ballantine Laboratories Inc., Boonton, N.J., announces the availability of its Model 421A ac/dc high voltage calibrator with associated Model 2421 error computer, designed primarily for the calibration of electronic voltmeters and oscilloscopes. Ballan-

time reports that any desired ac or dc voltage may be set, with three knobs, to an accuracy of 0.15% to 110 v, and 0.3% at 1110 v.

Two new voltmeters recently introduced by Ballantine are its Model 323, a true rms all solid-state unit capable of operation from a self-contained rechargeable battery or from a 115/230 v, 50-400 hz power source having a frequency band of from 10 hz to 20 Mhz; and its Model 303—with rechargeable battery or same power source as the 323 but having a frequency band of from 2 hz to 6 Mhz.

Circle Reader Service Card No. 100

### Xenon & Mercury Arc Lamps

Illumination Industries, Inc., Sunnyvale, Calif., offers its complete line of xenon and mercury short-arc lamps and appropriate power supplies. All xenon-line lamps are for dc operation and include 2- and 3-electrode models for 35, 75 and 150 watts with a 3-electrode model only for 300-watt operation.

The mercury short-arc lamps include the following options: 100 watts, 2 and 3 electrodes for dc operation; 200 watts, 2 or 3 electrodes for ac/dc operation; 350 watts, 2 electrode dc operation; and, 500 watts, 2 electrode dc operation. A wide assortment of power supplies which are available include CA-35 for xenon lamps of 35 watts and smaller; CA-75/100 for 75-watt xenon and 100 watt mercury; CA-150 for 150-watt xenon; and CA-200 for 200-watt mercury.

Circle Reader Service Card No. 101

## New Literature

### Decimal-Visual Translator

Shelly Associates, El Segundo, Calif., offers Bulletin 66-040, describing the new TR-100 Decimal to Visual Translator, a high-reliability module for translating decimal code into accurately energized seven-bar display segments.

Circle Reader Service Card No. 102

### Indicator Lights

Dialight Corp., Brooklyn, N.Y., offers a 16-page, fully-illustrated catalog which presents a wide array of miniature and large indicator light (many of which meet or exceed the requirements of MIL-L-3661, according to the manufacturer) for use with neon or incandescent light sources. Also included are tamper-proof open-type assemblies and lens caps for panel mounting.

Covered in the catalog are indicator lights for mounting in 9/32, 7/16, 11/16 and 1 in. clearance holes — each fully documented with data, materials and finishes, and catalog number charts to simplify selection and procurement. Hot-stamped or engraved legends are available with many series for read-out applications. Lamp charts are also provided, giving a complete listing of the appropriate lamps for the series of indicator lights in question.

Circle Reader Service Card No. 103

## WANT A CHANCE TO DISPLAY YOUR TALENTS?

THE DATA SYSTEMS DIVISION OF LITTON INDUSTRIES IS CURRENTLY OFFERING UNIQUE OPPORTUNITIES FOR INFORMATION AND SYSTEMS DISPLAY ENGINEERS



WHAT YOU'LL BE DOING



You will be involved in the design and development of advanced microelectronic display systems utilizing multiple gun CRT techniques. Your assignments will include systems design, development of overall specifications, and advanced circuitry and electronics to meet the system requirements. For these projects we need graduate engineers with experience in high resolution cathode ray techniques, storage tube display equipment, scan convertor techniques and circuitry and application of microelectronic techniques to display equipment.



WHAT WE'VE DONE



The Data Systems Division is notable for the design and development of the highly mobile MTDS (Marine Tactical Data System) and the ATDS (Navy Airborne Tactical Data System) for the E2A aircraft. We are engaged in the following systems work: air defense, air traffic control, command and control, data processing and display, reconnaissance, space information and surveillance.

### WHAT WE'RE DOING NOW

#### LC-25, 25 Megacycle Radar Sweep Converter

This unit accepts radar sweep data from a Radar Azimuth Converter, symbol position data from a computer, and converts these for application to a display console. The high speed capability of the unit, utilizing primarily integrated circuits, permits display of high resolution sweeps at lower ranges than previously possible, with no switching disturbances. Current mode integrated circuits and Digital-to-Analog converters are used.



Typical of current DSD projects are these advancements:

#### Advanced Display Console

The Advanced Display Console is a product of Litton's continuing program to develop a line of display modules, with which displays to suit the varied applications can be constructed. Emphasis has been placed on standardization of components, reduction in weight and power, and advanced display techniques. Modules designed and constructed include Radar Azimuth Converter, Symbol Generators, Data Entry and Readout Units, and both electromagnetic and electrostatic CRT Display Units.



#### Litton's Entry Query Control Console

Designed as an interface unit for Litton's L-300 line of Microelectronic Computers, the EQCC replaces the keyboards and push-buttons usually found on Computer-control consoles. With the advantage of being programmable, it can be tailored to any type of operation or level of operator skill. It is completely self contained, with microelectron symbol generator and microelectron power supplies.



LITTON INDUSTRIES DATA SYSTEMS DIVISION

— An Equal Opportunity Employer —

When you need the eye quicker than the hand, look to IMC.



We're an old hand at flag indicators.

No springs—they're magnetically detented, use jeweled bearings, balanced rotors and are ultra reliable. If you indicate, Measure, or Control, using flag indicators, synchros, resolvers, steppers or solenoids they're in stock at IMC Magnetics Corp., Western Division. For quick service contact the Applica-

tions Section at 6058 Walker Ave., Maywood, California, 90270. Phone (213) 583 4785 or TWX 910 321 3069. If you need data sheets for reference or consideration for future projects, write IMC's Marketing Division at 570 Main Street, Westbury, N.Y. 11591 or circle the bingo card number at the bottom of this ad.

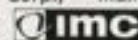

## SID Sustaining Members

AEROSPACE CORPORATION  
SAN BERNARDINO, CALIFORNIA

CELCO  
(CONSTANTINE ENGINEERING LABS. CO.)  
MAHWAH, NEW JERSEY

COMMUNICATIONS & ELECTRONICS DIV.

PHILCO CORPORATION  
A SUBSIDIARY OF FORD MOTOR COMPANY  
WILLOW GROVE, PENNSYLVANIA

CONRAC DIVISION  
GIANNINI CONTROLS CORP.  
GLENORA, CALIFORNIA

FAIRCHILD DUMONT LABORATORIES  
CLIFTON, NEW JERSEY

HUGHES AIRCRAFT COMPANY  
VACUUM TUBE PRODUCTS DIV.  
OCEANSIDE, CALIFORNIA

ITT FEDERAL LABORATORIES  
A DIVISION OF INTERNATIONAL TELEPHONE AND TELEGRAPH CORPORATION  
NUTLEY, NEW JERSEY

LING TEMCO VOUGHT  
MILITARY ELECTRONICS DIVISION  
DALLAS, TEXAS

NAC INCORPORATED  
7-1 GINZANISHI  
CHUO-KU, TOKYO, JAPAN

RADIATION, INC.  
MELBOURNE, FLORIDA

STROMBERG CARLSON CORP.  
DATA PRODUCTS  
SAN DIEGO, CALIFORNIA

SYLVANIA ELECTRONIC TUBES DIV., SYLVANIA ELECTRONIC PRODUCTS, INC.  
SENECA FALLS, NEW YORK

TELEVISIO ELECTRONICS DIVISION  
DOUGHBODY INDUSTRIES  
WHEELING, ILLINOIS

## ID Advertisers

ADAMS ASSOCIATES ..... 8 Agency: Salinger & Ennegeess	GRANGER ASSOCIATES ..... 90 Agency: West	OAK ELECTRO/NETICS CORP. .... 49 Agency: Buchen Advertising
ALCO ELECTRONICS ..... 79 Agency: Marketronics	HUDSON LAMP ..... 46 Agency: Reast & Connolly, Thoma & Gill	OPTOMECHANISMS, INC. .... 18 Agency: Beecher Associates
AUTO-TROL CORPORATION ..... 57	I B M CORPORATION, D P DIV. 50, 51, 20 Agency: Marsteller	PATWIN ELECTRONICS ..... 80 Agency: Graeceman
BELOCK INSTRUMENT CORP. .... 59 Agency: Tri County Advertising	I M C MAGNETICS ..... 92 Agency: Monad	PERFECTION MICA CO. .... 84 Agency: Burton Browne
BENSON-LEHNER CORP. .... 81 Agency: Bonfield	INDUSTRIAL ELECTRONIC ENGINEERS ..... 12 Agency: Gumpertz, Bentley & Dolan	PHOTOMECHANISMS INC. .... 86 Agency: Thomsbranch Service
BETA INSTRUMENTS ..... 88 Agency: Stanley B. Tippett and Associates	INFORMATION DISPLAYS, INC. .... 67 Agency: George Taubert	PINLITES INC. .... 83 Agency: Associated Graphics
BUNKER-RAMO CORP. .... 65 Agency: Bodige-Eade	ITT INDUSTRIAL PRODUCTS DIV. .... 69 Agency: Gross Adv. Service	RAULAND CORP. .... Back Cover
BURROUGHS CORP. .... 5 Agency: Conli	JAY-EL PRODUCTS ..... 94 Agency: Lynn-Western	RAYTHEON ..... 16, 17 Agency: Fuller & Smith & Ross
CALIFORNIA COMPUTER ..... 63 Agency: Advertisers Production	LEE HOTELS ..... 88 Agency: M. J. Beckman Associates	RICHARDSON CAMERA CO. .... 70 Agency: Datagraphic Advertising
CELCO (Constantine Engineering Labs) .. 77 Agency: Stano	LITTON INDUSTRIES/ DATA SYSTEMS ..... 93 Agency: West, Weir & Bartel	SHELLY ASSOCIATES ..... 10 Agency: William E. Wilson
CONTROL DATA, INC. .... 14 Agency: Klau-Van Pietersom-Dunlap	LITTON INDUSTRIES/ ELECTRON TUBE DIV. .... 75 Agency: West, Weir & Bartel	SPECTRA-PHYSICS, INC. .... 2 Agency: Hal Lawrence
DIALIGHT CORP. .... 79 Agency: H. J. Gold	LITTON INDUSTRIES/ USECO DIV. .... 71 Agency: West, Weir & Bartel	SPINDLER & SAUPPE ..... 56 Agency: Balsam Advertising
DIGITRAN CO. .... 6 Agency: Hammer & Ormsby	MAGNETIC RADIATION LABS, INC. .... 73 Agency: W. H. Van Riper	SWITCHCRAFT, INC. .... 82 Agency: William Hart Adler
DYNAIR ELECTRONICS INC. .... 85 Agency: Mesa/Copy	MAST DEVELOPMENT CO. .... 88 Agency: Paul Mendy	SYLVANIA ..... 91 Agency: Kudner
ELDEMA CORP. .... 97 Agency: West, Weir & Bartel	MASTER SPECIALTIES CO. .... 9 Agency: William E. Wilson	SYNTRONIC INSTRUMENTS, INC. .... 15 Agency: Burton Browne
FAIRCHILD DUMONT LABS ..... 87 Agency: Coati	MILGO ELECTRONIC CORP. .... 11 Agency: Palmer, Willson & Worden	TINSLEY LABS ..... 62 Agency: Vernon Cash
GAMMA SCIENTIFIC ..... 78 Agency: Barnes Champ	NATIONAL ELECTRONICS ..... 78 Agency: Connor-Safer	TRANSISTOR ELECTRONICS CORP. .... 21, 22 Agency: Stevenson & Assoc.
GENERAL ATRONICS CORP. .... 55 Agency: Garcon, Hargrave & McCullough		TUNG-SOL ELECTRONICS ..... 72 Agency: E. M. Freystadt
GENERAL ELECTRODYNAMICS ..... 7 Agency: Evans, Young & Wyatt		VACTEC INC. .... 52 Agency: Coleman & Assoc.
GEO SPACE ..... 19 Agency: Hal Jones		VIDEO COLOR CORP. .... 74
		WARNECKE ELECTRON TUBES ..... 66

## QUALIFIED SOURCE on APOLLO Spacecraft illuminated pushbutton switches

Jay-El Illuminated Pushbutton Switches are designed and qualified to North American Aviation specifications. Now in production at Jay-El under the rigorous NASA, SAID and NASA quality assurance and acceptance requirements. Choice of various methods of illumination techniques available. Consult us for illuminated indicator and switching functions for operation in space environments.



Write for  
full technical  
information

**JAY-EL PRODUCTS, INC.**

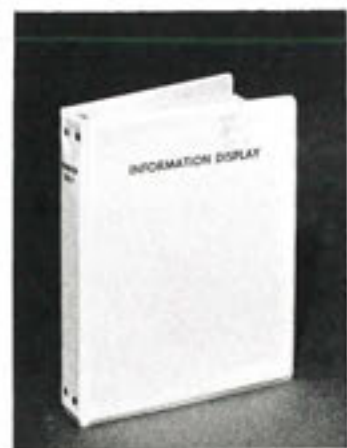

**A HANDY,  
HANDSOME  
BINDER FOR  
12 ISSUES OF  
INFORMATION  
DISPLAY**

(a two-year supply)

**\$4.50**

Now you can build an Information Display reference library and retain bi-monthly issues of the Journal intact in a beautiful gold-and-white vinyl binder. Twelve flexible steel rods hold a two-year supply of ID, permitting easy entry and removal without damage to your copies. Gold lettering on the binding and front cover provides ready identification. Reinforced stiffening throughout and durable, easy-to-clean vinyl covering make this binder a handsome addition to your office or home library. Order your binder today. Send check or money order to:

**INFORMATION DISPLAY**

647 N. Sepulveda Blvd., Bel Air, Los Angeles, Calif. 90049

## Eldema makes lites

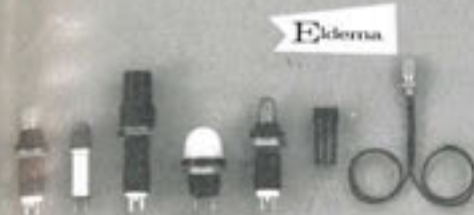

**All sizes, shapes and colors**

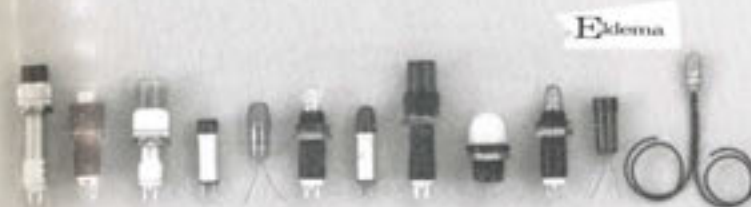

**Panel lites for all purposes**



**Specify lites by Eldema!**



This array is just part of the parade of Eldema lites for industry, which range from instrumentation panel lights and test equipment indicators to commercial pilot lights and computer data readout and display.   Most standard types are available off-the-shelf from your local Eldema distributor. Our line of pilot lights includes single

neon or incandescent lamp types and complete assemblies incorporating transistorized driver networks.   Specify Eldema, where reliability comes in just the size, shape and color you need!   Representatives and distributors in principal cities. Write or call today for specifications and quotations.

**ELDEMA CORPORATION**

A SUBSIDIARY OF

**Genisco**

**TECHNOLOGY  
CORPORATION**



18435 SUSANA ROAD ■ COMPTON, CALIFORNIA 90221 ■ PHONE (213) 774-1850 ■ TWX 213-630-3380

Circle Reader Service Card No. 108